

2011 UPDATED CATALOG

CALL: 1-800-532-1932

COMING SOON !!!- TRY OUR
WEBSITE AT: allfordparts.com
E-mail: allford@jps.net

1909



1948

POLICIES

TOLL FREE ORDER NUMBER: 1-800-532-1932

- RETURNS** All items returned must be accompanied with a copy of the invoice. No returns on electrical items. Returns will not be accepted if the item has been altered, painted, primered or modified. No returns on special order or custom items. Returns after 30 days are subject to a 20% RESTOCKING FEE. No returns will be accepted after 6 months. Returns must be shipped pre-paid at owners expense. NO C.O.D.'s are accepted.
- CORES** Rebuilt or refurbished items will require a core or be charged a core charge prior to shipping. Core charges will be refunded when a rebuildable core is returned with a copy of the invoice. The core returned must be able to be rebuilt in order to receive a full refund. Cores that are damaged or rusted beyond repair will not be given a refund. All core returns must be shipped pre-paid at owners expense. No C.O.D.'s are accepted.
- DAMAGES - SHORTAGES** All claims for damages or shortages must be made within 48 hours of receiving your package. Claims on freight shipments must be made at time of receipt to the courier of the freight company before he leaves your business/residence. Please keep all packaing & cartons until claim has been completed. Please make driver note in system any visable damage of packaging to the driver at time of delivery.
- FOREIGN ORDERS** Payable in U.S. FUNDS only; by money order, bank check, or VISA/ DISCOVER/MASTERCARD (BEST & FASTEST). Please add 25% for shipping. There will be no backorders on foreign orders - please reorder.
- PRICE CHANGES** Due to unforeseen price increases from our suppliers, prices are subject to change without notice. Additional charges will be charged to your credit card or sent C.O.D.
- ORDERING** Phone, mail, fax or e-mail orders accepted. Please have all information available at time of order to help speed your order along. We accept VISA, MASTERCARD or DISCOVER, money orders and personal checks (may delay order). We also ship C.O.D. (Additional \$10 shipping). All items are shipped via Fed-Ex or USPS. Unless specified, all items that are temporarily out-of-stock will be backordered. Most backorders will be shipped within 1-3 weeks.
- SALES TAX** CALIFORNIA residents: Include sales tax rate of 7.5% for orders shipped. 8.5% over the counter.
- SHIPPING** Orders are primarily shipped by Fed-Ex or USPS. Items exceeding Fed-Ex weight or size limit will be shipped by truck freight or by Greyhound bus. (\$15 additional charge for orders shipped greyhound or freight requiring delivery to a depot or airport). Add \$10 for C.O.D. orders. Please specify if you would like a particular shipping method or delivery date/time. Shipping company is decided based on price, time-in-transit, & convience. Fed-Ex has a number of additional charges such as residential delivery, Rural delivery, and unusual & oversize pacakge. This will affect the final total of your shipping amount.

NEXT-DAY AIR, 2ND DAY AIR, 3RD DAY AVAILABLE AT ADDITIONAL COST

Shipping Price Estimates:

	Mail	Priority Mail			FedEx		
	Small under 1 lb	Flat Rate			Ground		
		Small	Medium	Large	Business	Resident	Rural-Residnt
Minimum:	\$2.75	\$6.00	\$11.50	\$15.20	\$6.64	\$9.83	\$12.73
Average:	\$3.50	\$6.00	\$11.50	\$15.20	\$9.60	\$12.02	\$15.55
	Small items only, no tracking	Parts must fit in flat rate size box. Insurance for \$50-\$250 add \$1. 2-3 est. delivery time.			Rural is for businesses/homes not in or near a major city. Average prices are estimates only. Large/Irregular shape items add \$8 and up.		

Insurance Rates:	\$100-\$500	\$1.00	\$500+	\$2.50 & up
-------------------------	-------------	--------	--------	-------------

International: International shipments primarily ship out USPS Priority Mail, we try to get you the cheapest rate possible. Please call or email you order and we can give you a rate quote for shipping.

*Average is an estimate of our average order with no dimension exceeding 24" and under \$500.00. Larger orders are harder to estimate shipping amount. Running boards, bumpers, fenders, and other large items please call for shipping quotes.

INDEX

FOR THIS CATALOG WE HAVE, FOR THE MOST PART, USED FORD'S ORIGINAL NUMBERING SYSTEM. BELOW WE HAVE LISTED THE GROUP, GROUP NUMBERS AND THE PAGES EACH GROUP OCCUPIES IN OUR CATALOG. A MORE SPECIFIC INDEX IS INCLUDED ON THE FOLLOWING PAGES FOR YOUR CONVENIENCE. IF YOU CAN'T FIND WHAT YOU NEED PLEASE INQUIRE!

WHEELS, HUBS & TIRES

1000-1723 6 to 10

BRAKES

2004-2666 11 to 15

FRONT AXLE

3010-3446 16 & 17

STEERING GEAR

3503-3743 18 to 20

REAR AXLE

4000-4906 21 to 23

FRAME & BRACKETS

5000-5149 25 & 26

BATTERY BRACKETS & PARTS

5150-5199 26 & 27

MUFFLER & EXHAUST PIPE

5230-5293 27 & 28

SPRINGS

5300-5818 28 & 29

ENGINE

6000-6928 31 to 36

TRANSMISSION

7000-7449 37 to 40

CLUTCH

7500-7646 40 & 41

RADIATOR

8000-8499 43 to 51

WATER PUMP

8500-8599 49

FAN

8600-8693 49 to 52

FUEL TANK

9001-9326 53 to 55

FUEL PUMP

9270-9420 55 & 56

MANIFOLDS, CLAMPS, ETC.

9421-9499 56

CARBUREATOR

9502-9685 56 & 57

THROTTLE CONTROL

9700-9828 56 to 61

GENERATOR & BATTERY

10000-10848 63-64

INSTRUMENTS

10849-10899 54, 55, 64 & 109

STARTER MOTOR

11000-11516 65

LIGHT SWITCH

11648-11688 66

IGNITION

12000-12425 70 to 72

LAMPS

13002-13799 74 to 83

HORN

13800-13899 85 & 86

WIRING

14054-14621 66 TO 69, 87 & 88

ACCESSORIES

15001-15709 89 to 91

FENDERS

16000-16449 92 to 94

RUNNING BOARD

16450-16599 95 to 97

HOOD

16600-16799 98 to 107

SPEEDOMETER

17250-17499 109 & 110

WINDSHIELD WIPER

17500-17674 110 to 113

MIRRORS

17679-17745 114 to 117

BUMPERS

17750-17999 118 to 120

SHOCK ABSORBER

18000-18199 121

ACCESSORIES

18400-18600 121 to 128

FASTENERS 129 to 135

FLOOR SEALS 137, 138 & 172

COWL VENT 138

BODY PATCH PANELS 139 & 140

DOOR HARDWARE 140 & 141

WINDSHIELD FRAMES 142 to 144

SHEET METAL 145 to 148, 227 to 228

RUMBLE SEAT 149 & 150

TOP IRONS 151

CONVERTIBLE 152 to 154

GLOVE BOX 154

WINDOW CHANNEL 155 to 158

DOOR SCUFF PLATES 159

SUN VISORS 160

WINDOW REGULATORS 161

DOOR PULLS & LOCKS 141, 162

DOOR SEALS 163 & 164

SEAT SPRINGS 165 to 168

STRIKER PLATES 140, 150 & 169

WOOD 170 to 172

PICKUP 173 TO 177, 180

TRANSMISSION COVERS 178

FLOOR MATS 179

FIREWALL INSULATION 181

WINDOW SEALS 152, 153 & 182 to 184

TRUNK 185 & 186

HANDLES & CRANKS 83, 84, 187 to 193

ESCUTCHEONS 191

FIBERGLASS 194 to 204

DECALS 136

BOOKS 219 to 226

STREET ROD 205 to 264

INDEX

A

A-ARMS 247-249
 ACCELERATOR PEDAL 57
 ACCESSORIES (STREET ROD) 89-91, 121-124, 262,263
 ADAPTERS (ENGINE TO TRANSMISSION) 42
 AIR CLEANER 56, 211
 ANTENNAS 126
 ANTI-SQUEAK PAD 120
 ANTI-ROLL BAR 246,256
 APRONS 93
 ARM RESTS 169, 205
 ASH TRAY KNOBS 61
 ASH TRAYS 61
 AXLE ASSEMBLIES (STREET ROD) 245
 AXLE BOLTS 16
 AXLE BUMPERS (FRONT) 16
 AXLE BUMPERS (REAR) 29
 AXLE - DROPPED 245, 250

B

BACK WINDOW FRAME 151
 BACK WINDOW RUBBER 184
 BACKUP LAMP SWITCH 91
 BATTERY 64
 BATTERY BOX 26, 210, 262
 BATTERY CABLES 87
 BATTERY CABLE BRACKETS 87, 88
 BATTERY DEFLECTOR 26,178
 BATTERY DISCONNECT SWITCH 87
 BATTERY HOLD DOWN FRAME 26
 BATTERY HOLD DOWN PAD 26
 BEAUTY RINGS 7
 BED FLOORING (WOOD) 176
 BED FLOORS 174
 BED STRIPS 176
 BELTS 51
 BELT BUCKLES & CAPS 128
 "BLACK BOX" 207
 BLUE DOT LENS 81
 BODIES STEEL (FIBERGLASS) 146 (194)
 BODY EMBLEMS 94, 175, 178, 179, 213
 BODY INSULATION 181
 BODY-TO-FRAME GUSSET 178
 BODY MOULDING CLIPS 129
 BODY MOULDINGS 102, 107
 BODY NUMBER PLATES 124
 BODY PANELS 139, 140, 146-8
 BODY PATCH PANELS 139
 BODY-TO-FRAME PADS 25, 120
 BODY SOCKETS 134
 BOLT KITS 134, 135
 BOOKS 219 TO 226
 BRAKE PARTS 11 TO 15, 246-259
 BRAKE COMPONENTS (STREET ROD) 211, 246-259
 BRAKE & CLUTCH PEDAL BUMPERS 137
 BRAKE & CLUTCH PEDAL PADS 14, 262
 BRAKE DRUMS 8
 BRAKE FLUID 259
 BRAKE HANDLE 15, 259
 BRAKE HOSE 12, 259
 BRAKE LINES 13, 259
 BRAKE LINING 11
 BRAKE PEDAL ASSEMBLIES 211, 259
 BRAKE RODS 14
 BRAS 91
 BUG SCREENS 45
 BUMPER PARTS 119 TO 120
 BUMPER BOLTS 119
 BUMPER BRACKETS 118
 BUMPER BRACKET GROMMETS 120
 BUMPER GUARDS 119
 BUMPER TIPS 120
 BUMPER-TO-BODY SEAL 120
 BUMPERS 118
 BUMPERS (DOOR) 158

C

CAMSHAFT 33
 CAMSHAFT BEARINGS 34
 CAPS 124
 CARBURETOR 56, 57
 CAR COVERS 91
 CHASSIS - STREET ROD 234-243
 CHOKE RODS 56
 CHOKE ROD & CABLE KITS 62
 CHASSIS AND FRAMES 233-243
 CHASSIS COMPONENTS 246-262
 CHASSIS (PRO-COMP) 242, 243
 CIGAR LIGHTERS 90, 108
 CIRCUIT BREAKER 71
 CLOCK ASSEMBLY 89
 CLEVICE 264
 CLOCK BEZEL 60
 CLOCK FACE 89
 CLOCK KNOB 89
 CLOCK LIGHT WIRE 66, 89
 CLOCK MIRRORS 115

CLOCK PANELS 60
 CLUTCH PARTS 40, 41
 COLUMBIA REPAIR KIT 22
 COLUMBIA DECAL 225
 COLUMBIA KNOBS 153
 COLUMBIA INSTRUCTIONS 225
 COIL 70
 COIL-OVERS 247, 248, 251, 255
 CONDENSERS 71
 CONDENSER BOOT 71
 CONNECTING RODS 33
 CONVERTIBLE DOOR BUMPER KIT 158
 CONVERTIBLE HEADER BRACKET 151
 CONVERTIBLE RUBBER 152, 153
 CONVERTIBLE TOP IRONS 151, 204
 CONVERTIBLE TOP PARTS 151 TO 154, 204
 CONVERTIBLE WINDOW CHANNEL 152
 COMPRESSOR, AIR CONDITIONING 207
 COOLING SYSTEM 43 TO 52
 COOLING SYSTEM (STREET ROD) 260
 COWL-TO-FENDER SEAL 93
 COWL-TO-FIREWALL SEAL 138
 COWL LACING 104
 COWL LAMPS 77, 78
 COWL LAMP LENS 78
 COWL LAMP PADS 78
 COWL MIRRORS 116
 COWL MOULDINGS 107
 COWL PATCH PANELS 139
 COWL TRIM 107
 COWL VENT GASKET 138
 COWL VENT HANDLE 138
 COWL VENT HINGE 138
 COWL VENT KNOBS 59
 COWL VENT LID 138, 201
 COWL VENT PARTS 138, 139, 201
 COWL VENT RATCHET 138
 COWL VENT SCREEN 138
 CRANK HOLE COVER 47
 CRANKING TOOL 109
 CRANKSHAFT GEAR 34
 CROSSMEMBERS (STREET ROD) 212, 246, 248, 255, 261
 CROSSOVER PIPE 27
 CURTAIN ROD SOCKET 134
 CUT-OUT SWITCH 63
 CYLINDER HEAD 31, 42
 CYLINDER HEAD HARDWARE 31, 32
 CYLINDER SLEEVE 31

D

DASH GROMMETS 57
 DASH INSULATORS 181
 DASH KNOBS 58, 59, 61, 108, 123
 DASH PANELS 60-62, 108
 DASH PLASTIC 60, 61
 DASH SWITCH (DIMMER) 84
 DASH TRIM 60
 DATA PATENT PLATES 124
 DECALS 136, 225
 DECK EMBLEM 83
 DECK PANEL 95, 147, 148, 203
 DECK LID BUMPER 185
 DECK LID HANDLE 83, 84
 DECK LID HANDLE BASE 84
 DECK LID HANDLE PAD 84
 DECK LID HINGE 186
 DECK LID LATCH 84
 DECK LID LIGHT SOCKET 83
 DECK LID SEAL 185
 DECK LID STRIKER PLATE 169
 DECK LID SUPPORT 186
 DEFROSTER HOSE 122
 DEFROSTER KNOB 123
 DEFROSTER NOZZLE 122
 DIAL FACE GLASS (RADIO) 125
 DIAL FACE (RADIO) 125
 DIFFERENTIAL 21 TO 23, 263
 DIFFERENTIAL COVER PLATE 178
 DIMMER SWITCH 80
 DIP STICK 36, 214, 215, 263
 DIP STICK TUBE BOSS 31
 DISC BRAKE 246, 247, 257, 258
 DISTRIBUTOR BOOT 70
 DISTRIBUTOR CAP 70
 DISTRIBUTOR GASKET 70
 DISTRIBUTOR PARTS 70, 71
 DISTRIBUTOR PLUG 107
 DIVISION BAR (WINDSHIELD) 71
 DOME LAMP 85
 DOME LAMP LENS 85
 DOME LAMP SWITCH PLATE 85
 DOOR ARM RESTS 169
 DOOR ASSIST STRAPS 162
 DOOR BUMPERS 158
 DOOR CHECK ARM KITS 162
 DOOR CHECK ARM STRAPS 162

DOOR DOVETAIL 140
 DOOR EDGE MIRRORS 116
 DOOR ESCUTCHEON PADS 189-191
 DOOR GLASS SEAL 155, 156, 168
 DOOR HANDLES (INSIDE) 187 TO 189, 205
 DOOR HANDLES (OUTSIDE) 192, 193
 DOOR HANDLE PADS 193
 DOOR HANDLE PINS 189
 DOOR HANDLE SETS 187 TO 189
 DOOR HINGE PINS 131, 158
 DOOR HINGES 141
 DOOR HINGE (GLOVE BOX) 154
 DOOR HINGE MIRROR 116, 117
 DOOR JAM SEALS 163, 164
 DOOR LATCHES 141
 DOOR LATCH PULL 141, 162
 DOOR LOCK ESCUTCHEON 190
 DOOR LOCK (OUTSIDE) 162
 DOOR MOULDINGS 107
 DOOR PANELS 180
 DOOR PANEL CLIPS 129
 DOOR PANEL SPRING 190
 DOOR PARTS 140, 141
 DOOR PATCH PANELS 139, 140, 147, 148
 DOOR PULLS 162
 DOOR REGULATOR 161
 DOOR SCUFF PLATES 159
 DOOR SEALS & RETAINER CHANNELS 163, 164
 DOOR SEAL (BACK EDGE) 164
 DOOR SEAL (HINGE) 163
 DOOR SEAL (LOWER) 163
 DOOR SEAL (UPPER) 163
 DOOR SPRING 131, 141, 190
 DOOR STRAP BRACKET 162
 DOOR STRIKER PAD 140
 DOOR STRIKER PLATES 140
 DOOR TRIM 107
 DOOR WINDOW CHANNEL KITS 155 TO 158
 DOOR WINDOW FRAME SEAL 152
 DOOR WINDOW RETAINER 155 TO 157
 DOOR WINDOW TRIM PANEL 180
 DOVETAILS 140
 DRAG LINK 17, 252
 DRAG LINK SEAL 17
 DRIVESHAFT PARTS 23
 DRIVESHAFT YOKE 23
 DROPPED AXLE 245, 250
 DUSTER 109

E

EDGE SEAL (DOOR) 164
 ELECTRICAL COMPONENTS (STREET ROD) 205, 206, 262
 ELECTRIC WIPER MOTORS 110, 111
 EMBLEM (FENDER) 94
 EMBLEM (GRILLE) 45, 48, 49
 EMBLEM (HOOD) 48, 98, 99
 EMBLEM (TRUNK) 83
 EMERGENCY BRAKE CABLES 14, 15
 EMERGENCY BRAKE HANDLES 15
 EMERGENCY CABLE BOOT 14
 EMERGENCY CABLE BRACKET 13
 EMERGENCY CABLE GROMMET 12, 13, 57
 EMERGENCY CABLE GUIDE 13
 ENGINE ADAPTERS 42
 ENGINE SPECIFICATION BOOKS 220 TO 226
 ENGINE CROSSMEMBERS (STREET ROD) 212, 246, 248
 ENGINE MOUNTS (STREET ROD) 212, 261
 ENGINE OIL COOLER 260
 ENGINE PARTS 31 TO 36
 ENGINE SPLASH PANS 36
 ENGINE WIRING 67
 ESCUTCHEON (DOOR HANDLE) 190, 191
 ESCUTCHEON (DOOR LOCK) 190
 ESCUTCHEON (VENT WINDOW) 190
 ESCUTCHEON (WINDOW CRANK) 191
 EXHAUST DEFLECTORS 122
 EXHAUST MANIFOLDS 56
 EXHAUST PIPES 27, 28
 EXHAUST SYSTEM 27, 28
 EXHAUST SYSTEM (STREET ROD) 263

F

FAN ASSEMBLY 51, 62, 260
 FAN BELTS 51
 FAN SHROUD (STREET ROD) 43
 FEMALE DOVETAILS 140
 FENDER APRON 93, 94, 195, 199
 FENDER APRON BOLTS 93, 129
 FENDER APRON BUMPER 94
 FENDER BOLT KIT 92, 134
 FENDER BOOTS (REAR) 94
 FENDER BRACES 92, 94
 FENDER BRACE PANEL 93, 94
 FENDER CLAMP 93
 FENDER-TO-COWL SEAL 93
 FENDER EMBLEM 94
 FENDER GROMMET 120
 FENDER GUARD 94
 FENDER MOULDINGS 92



FENDER PANELS (INNER) 94
 FENDERS 94, 195 to 199
 FENDER PATCH PANELS 95
 FENDER SKIRTS (FIBERGLASS) 200
 FENDER SKIRT SEALS 122
 FENDER TRIM 92
 FENDER WELTING 93
 FENDER WELT (STAINLESS) 93
 FIBERGLASS BODIES 194
 FIBERGLASS DASH INSULATORS 181
 FIBERGLASS GRILLES 201
 FIBERGLASS FENDERS 195 to 199
 FIBERGLASS PARTS 145, 194 to 204
 FINGER PULL (WINDSHIELD) 144
 FIREWALL COVER CLIP 181
 FIREWALL GROMMET 57
 FIREWALL INSULATION 181
 FIREWALL SEAL 138, 210
 FIREWALL (STEEL) 210
 FLATHEAD SPEED EQUIPMENT 42
 FLOORBOARD SEALS 137, 138
 FLOORBOARDS 172, 210
 FLOOR COVER (BATTERY) 172, 178
 FLOOR COVER (TRANSMISSION) 178
 FLOOR MATS 179
 FLOOR MAT CLIP 129, 179
 FLOOR PAN 147, 227-229
 FLOOR PLUG 138
 FLOOR SEAL (STEERING TUBE) 137
 FLOOR SEAL (TRANSMISSION) 137
 FLOOR SHIFTER (STREET ROD) 283
 FLYWHEEL RING GEAR 35
 FOG LAMPS 91
 FOOT REST 57
 FORD PORCELAIN EMBLEM 48
 FORD PARTS TAGS 124
 FORD SCRIPT (HOOD) 98, 99
 FORD SIGN 124
 FRAME - STREET ROD 233, 242, 243
 FRAME BOXING PLATE 264
 FRAME HORN 26
 FRAME HORN COVERS 95, 200
 FRAME PAD 25
 FRAME PARTS 25, 26
 FRAME WEBBING 25
 FRAME (WINDSHIELD) 142
 FRAME WIRE CLIP 69
 FRONT AXLE 16, 17
 FRONT SUSPENSION (STREET ROD) 245-251
 FRONT FENDERS (FIBERGLASS) 195 to 199
 FUEL GAUGE 54
 FUEL GAUGE LIQUID 54, 64
 FUEL LINE 55
 FUEL PUMP 55
 FUEL SYSTEMS 53 to 56
 FUEL TANK 53, 216
 FUEL TANK-TO-SENDING UNIT ADAPTERS 211

G

GARNISH MOULDING 143, 145, 203
 GARNISH MOULDING INSERTS 145
 GAS APRON CHANNEL SEAL KIT 95
 GAS CAPS 53, 211
 GAS GAUGE COVER 53
 GAS LID BUMPER 53, 103
 GAS NECK CLAMP 53
 GAS NECK GROMMET 54
 GAS NECK HOSE 53
 GAS PEDAL 57
 GAS PEDAL ROD 57
 GAS SENDER GASKET 54
 GAS SENDER FLOAT 54
 GAS TANK 53, 216
 GAS TANK BOLT 53
 GAS TANK COVER 96
 GAS TANK COVER (FIBERGLASS) 200
 GAS TANK COVER SCREW 132
 GAS TANK PAD 55
 GAS TANK PARTS 53 to 55
 GAS TANK SEALER 53, 216
 GAS TANK SENDING UNIT 54, 211
 GASKET, COWL VENT 138
 GASKET, DECK LID 94
 GASKET, DISTRIBUTOR 70
 GASKET, HEADLIGHT 75, 76
 GASKET, HOOD ORNAMENT 50, 103
 GASKET, INSTRUMENT PANEL 54
 GASKET, LICENSE BRACKET 80
 GASKET, LICENSE LIGHT 80
 GASKET, PARKING LIGHT 77
 GASKET, STEERING BOX 18
 GASKET, TAIL LIGHT 81
 GAUGE FACES 54, 55, 109
 GAUGE, TEMPERATURE 84
 GAUGES (STREET ROD) 262
 GEAR OIL 218
 GEAR SHIFT BOOT 40, 137

GEAR SHIFT GROMMET 39, 40
 GEAR SHIFT INDICATOR 207
 GEAR SHIFT KNOBS 39, 59
 GEAR SHIFT REPAIR KIT 40
 GENERATOR BELTS 51
 GENERATOR PARTS 63, 206
 GLASS BUMPER 158
 GLASS PATTERNS 142
 GLASS SETTING TAPE 143
 GLOVE BOX 154
 GLOVE BOX DOOR 108, 202
 GLOVE BOX DOOR BUMPER 154
 GLOVE BOX DOOR HINGE 154
 GLOVE BOX DOOR REPAIR KIT 154
 GLOVE BOX DOOR SPRING 154
 GLOVE BOX DOOR STOP 154
 GLOVE BOX LOCK 154
 GLUE, RUNNING BOARD COVER 95, 218
 GLUE, WEATHERSTRIP 185, 218
 GRAVEL DEFLECTOR 119, 120, 204
 GREASE FITTINGS 15, 51, 133
 GREYHOUND RADIATOR ORNAMENTS 49
 GRILLE BARS 44, 45, 47
 GRILLE BUMPERS 120
 GRILLE CENTER 44, 45, 50
 GRILLE CLIPS 44, 80, 129
 GRILLE COMPONENTS 44 to 50, 209
 GRILLE, DELUXE 46
 GRILLE EMBLEM 45, 48, 49, 76
 GRILLE GUARDS 120
 GRILLE GUARD STIFFENER 120
 GRILLE HARDWARE KIT 130
 GRILLE INSERTS 46, 47, 209
 GRILLE MOULDING CLIPS 50, 106, 129
 GRILLE MOULDINGS 50, 106
 GRILLE ORNAMENTS 45, 48
 GRILLE PAD 120
 GRILLE PAN 45, 47, 52
 GRILLE PAN BUMPER 120
 GRILLE PARTS 44 TO 50, 209
 GRILLE SCREEN 45
 GRILLE SCRIPTS 213
 GRILLE SHELL 46, 201, 209
 GRILLE SHELL GROMMET 88
 GRILLE SHELL ORNAMENTS 48, 49
 GRILLE, STANDARD 48
 GRILLE SUPPORT 44, 47, 52
 GRILLE TRIM 44 to 50, 106
 GRILLE-TO-FENDER APRON 50
 GRILLE VENT PANELS 94
 GROMMETS 57
 GUARD, BUMPER 119
 GUARD, FENDER 94
 GUSSET PLATE 178

H

HALOGEN REFLECTOR KIT 75
 HANDLE, COWL VENT 138
 HANDLES (DECK LID) 83, 84
 HANDLES, DOOR 187 to 193
 HANDLE, DOOR OUTSIDE 192, 193
 HANDLE, PULL 162
 HANDLE, WINDSHIELD 183
 HEAD GASKETS 30
 HEADER BRACKET 151
 HEADER BUMPER 153
 HEADER SEAL 145, 153
 HEADER STRIP, METAL 144
 HEADLAMP 74
 HEADLAMP ADAPTER 74
 HEADLAMP BARS 76
 HEADLAMP BOLTS 76, 132
 HEADLAMP BUCKETS 73
 HEADLAMP CLIP 76
 HEADLAMP CONDUIT 88
 HEADLAMP CONDUIT REPAIR 88
 HEADLAMP GROMMET 88
 HEADLAMP LENS 76
 HEADLAMP PADS 76
 HEADLAMP PARTS 73 to 76
 HEADLAMP PLUG 88
 HEADLAMP, QUARTZ BULB 74
 HEADLAMP REFLECTOR 75
 HEADLAMP PIMS 75
 HEADLAMP RIM REPAIR KIT 72, 132
 HEADLAMP RIM SCREWS 75, 132
 HEADLAMP, SEALED BEAM 73, 74
 HEADLAMP SHELL GROMMET 88
 HEADLAMP SHELL REPAIR 72, 132
 HEADLAMP STAND 76
 HEADLAMP WIRE 66, 67
 HEADLAMP WIRE CROSSOVER CHANNEL 66
 HEADLINER 180
 HEATER 122, 123, 205
 HEATER HOSE 122
 HEATER HOSE BRACKET 91
 HEATER HOSE CLAMPS 122

HEATER HOSE CONNECTOR 91, 122
 HEATER KNOB 123
 HEATER PARTS 91, 122, 123
 HIGH BEAM JEWEL 84
 HINGE, DOOR SEAL 163
 HINGE PAD, HOOD 103
 HINGE PINS 131, 158
 HINGES (TRUNK LID) 186
 HOG RINGS 165
 HOOD ARM SPRING 103
 HOOD BOLTS 99
 HOOD BRACKETS 47, 102
 HOOD BUMPER KITS 105
 HOOD CENTER 102, 103
 HOOD CLIPS 103
 HOOD EMBLEMS 49, 98, 99
 HOOD HANDLES 49, 102, 103
 HOOD HANDLE & LATCH MOUNTING KIT 135
 HOOD HANDLE PIN 49
 HOOD HANDLE SPRING BRACKET 102
 HOOD HINGE BRACKETS 47, 209, 263
 HOOD HINGE 103, 209
 HOOD HINGE HARDWARE KIT 105
 HOOD HINGE PAD 103
 HOOD LACE 104
 HOOD LATCHES 103, 209, 263
 HOOD LATCH CLIP 103
 HOOD LATCH SPRINGS 103
 HOOD MOULDING CLIPS 129
 HOOD ORNAMENTS 48, 49, 98, 99, 103
 HOOD ORNAMENT BASE PADS 50, 103
 HOOD ORNAMENT MOUNTING KIT 49
 HOOD PARTS 98 to 106, 209
 HOOD PULL GROMMET 57
 HOOD RELEASE HANDLE 49
 HOOD RELEASE KIT 264
 HOOD SAFETY CATCH 106
 HOODS 99 to 101
 HOOD SIDE MOULDINGS 102, 103, 106
 HOOD STOP BRACKETS 106
 HOOD SUPPORT 102, 209
 HOOD SUPPORT ARM 103
 HOOD TRIM 50, 102, 103, 106
 HORN BOLT 86
 HORN BRACKETS 86
 HORN BUTTON 20
 HORN BUTTON CUSHION 20
 HORN BUTTON SPRING 19
 HORN BUTTON WIRE 20, 68
 HORN COVER 85, 86
 HORN GRILLE 86
 HORN GRILLE PAD 86
 HORN GROMMET 86
 HORN/LIGHT SWITCH ROD 20
 HORN MOTOR WIRING 67, 86
 HORN RODS 20
 HORN SCREEN 86
 HORN TAG 86
 HORN WIRE 20, 68, 86
 HORNS 20, 85, 86
 HOSE CLAMPS 51, 53
 HOSE, RADIATOR 51
 HUBCAPS 6, 7
 HUB PARTS 8 to 10
 HYDEM WELT 160
 HYDRAULIC BRAKE ADAPTER KIT 15

I

IGNITION CYLINDER 20
 IGNITION KEYS 20, 162
 IGNITION LOCK SHIM 20
 IGNITION POINTS 70
 IGNITION RESISTOR 71
 IGNITION SWITCH 20
 IGNITION SWITCH PLATES 66
 INDEPENDENT FRONT SUSPENSION 248-249
 INSERT, GARNISH MOULDING 145
 INSIDE REARVIEW MIRRORS 114, 115
 INSTRUMENT GAUGE GLASS 64
 INSTRUMENT PANEL 60, 108, 206
 INSTRUMENT PANEL DIMMER SWITCH 84
 INSTRUMENT PANEL FACE SETS 109
 INSULATION, BODY 181
 INSULATION, FIREWALL 181
 INTAKE MANIFOLD GASKET 35
 INTAKE MANIFOLD WASHER 133
 INTERIOR TRIM SCREW KITS 130

K

KICK PANELS 180
 KICK PANEL RETAINERS 180
 KICK PANEL TRIM 180
 KICKDOWN KITS 214, 215
 KNOB PINS 16, 250
 KNOB, ANTENNA 127

INDEX

KNOB, ASH TRAY 61
 KNOB, CIGAR LIGHTER 90
 KNOB, CONVERTIBLE TOP 153
 KNOB, COWL VENT 59
 KNOBS (DASH) 58, 59
 KNOB, DEFROSTER 123
 KNOB, GEAR SHIFT 39, 59
 KNOB, HEATER 123
 KNOB, RADIO 125
 KNOB, WINDOW CRANK 183, 190

L

LADDER BAR KITS 212
 LATCH, TRUNK 84
 LENS, BLUE DOT 81
 LENS, COWL LIGHT 78
 LENS, DECK BASE 81
 LENS, DOME LIGHT 85
 LENS, HEADLIGHT 76
 LENS, LICENSE PLATE LIGHT 80, 81
 LENS, PARKING LIGHT 77
 LENS, TAIL LIGHT 81
 LICENSE HOLDER (FRONT) 25, 82
 LICENSE LAMP 83
 LICENSE LENS CLIP 80
 LICENSE LIGHT 83, 263
 LICENSE PLATE BACK 213
 LICENSE PLATE BOLT 82
 LICENSE PLATE BRACKET 82
 LICENSE PLATE FRAMES 83, 263
 LICENSE PLATE LIGHT LENS 80, 81
 LICENSE PLATE PAD, GASKET 81, 84
 LIGHT BULB 74, 81, 211
 LIGHT, COWL 77, 78
 LIGHT, HEAD 74 to 76
 LIGHT, PARKING 77
 LIGHT SWITCH BODY 66
 LIGHT SWITCH/HORN ROD 20
 LIGHT, TAIL 78, 79, 208
 LIGHTERS 90, 91, 108
 LOCK CYLINDER, DOOR 162
 LOCK, GLOVE BOX 154
 LOCKING GAS CAP 53
 LOOM, WIRE CONDUIT 67, 69, 88, 213
 LOWER DOOR SEAL 163
 LUG WRENCH 109
 LUGGAGE RACKS 124
 LUGGAGE RACK EMBLEM 124

M

MAIN BEARINGS 34
 MALE DOVETAILS 140
 MANIFOLD (EXHAUST) 56
 MAP CASE 109
 MASTER CYLINDER 13, 269
 MASTER CYLINDER COVER PLATE 138
 MASTER CYLINDER MOUNT BRACKET 211
 MASTER CYLINDER REPAIR KIT 11
 METAL TOP MOULDING 160
 MIRRORS 114 to 117, 205
 MIRROR, BRACKET INTERIOR 115
 MIRROR, DOOR HINGE 116, 117
 MIRROR, EXTERIOR 116, 117, 205
 MIRROR, INTERIOR 114, 115, 205
 MIRROR HEAD, DOOR 116, 117
 MIRROR HEAD, INTERIOR 116
 MOTOR MOUNTS (FRONT) 31, 212, 261
 MOTOR MOUNTS (REAR) 32
 MOULDINGS (BODY) 107
 MOULDING CLIP KITS 129
 MOULDING (TOP) 160
 MUFFLER 27
 MUFFLER SUPPORT 28

O

OIL CHEX GAUGE 84
 OIL COOLER 260
 OIL FILLER CAPS 36
 OIL GAUGE 54, 64
 OIL PAN GASKET SET 36
 OIL PUMP 36
 OPERA SEAT BUMPER 165
 OUTSIDE REARVIEW MIRRORS 116, 117, 205
 OVERHAUL GASKET SETS 30

P

PACKAGE TRAY (WOOD) 171
 PAD, COWL LIGHT 78
 PAD, HORN GRILLE 86
 PAD, RUMBLE STEP 149
 PAINT, ENGINE 31, 218
 PAINT, STEERING WHEEL 19
 PANEL, DASH 60-62, 106, 205
 PANHARD BAR 249, 256
 PARALLEL LINK 249
 PARKING LAMPS 77
 PARKING LAMP BOOT 77

PARKING LAMP LENS 77
 PARKING LAMP LENS CLIP 77
 PARKING LAMP PAD 77
 PARKING LAMP WIRE 77
 PATCH PANELS 95, 139, 140, 147, 227-229
 PATENT DATA PLATES 124
 PEDAL BUMPERS 14, 137
 PEDAL COVER PLATES 178
 PEDAL PADS 14
 PEDAL SEALS 137
 PEEP MIRRORS 116, 117
 PICKUP BED PARTS 172 to 177
 PICKUP BEDS 173
 PICKUP BED SIDE PANELS 175
 PICKUP BED STRIPS 176
 PIN, DOOR HANDLE 189
 PISTON RINGS 32, 33
 PISTONS 32
 PITMAN ARM 18, 252
 PLUG, ANTENNA HOLE 127
 PLUG WIRES 71
 POLY-RIDE 251
 PORCELAIN GRILLE EMBLEM 48
 POWER ACCESSORY BLOCK 207
 POWER BRAKE 258
 POWER WINDOW KITS 213

Q

QUAIL RADIATOR ORNAMENT 49
 QUARTER GLASS RUBBER 184
 QUARTER MOULDINGS 107
 QUARTER PANEL BRACES 139
 QUARTER PATCH PANELS 139
 QUARTER TOP PADS 153
 QUARTZ BULB 74

R

RACK & PINION 252
 RADIATOR BOLT KIT 43, 52
 RADIATOR CAPS 43, 260
 RADIATOR CAP REPAIR KIT 43, 49
 RADIATOR FAN SHROUD 43
 RADIATOR/FENDER BRACKET 43, 94
 RADIATOR GRILLE PAN 50, 52, 98
 RADIATOR GRILLE SHIELD 52
 RADIATOR HOSE 51
 RADIATOR HOSE CLAMP 51
 RADIATOR HOSE, LOWER 51
 RADIATOR HOSE, UPPER 51
 RADIATOR OVERFLOW TANKS 260
 RADIATORS 43, 260
 RADIATOR SHELL LACING 104
 RADIATOR SHELL MOUNTING 135
 RADIATOR SHROUD SEAL 52
 RADIATOR SPLASH APRONS 98, 200
 RADIATOR SUPPORT RODS 44
 RADIATOR SUPPORT ROD BRACKET 44
 RADIO ANTENNAES 126, 127
 RADIO CHANGER BUTTON 125
 RADIO COVER 125, 209
 RADIO DIAL 125
 RADIO DIAL BEZEL 125
 RADIO DIAL FACE 125
 RADIO DIAL FACE GLASS 125
 RADIO INSTALLATION BOOK 126
 RADIO KNOB 108, 125
 RADIO MOUNTING HOOK 126
 RADIO PANEL 61, 108, 125
 RADIO PARTS 125 to 127
 RADIO NUT 126
 RADIO SPEAKER BOOT 126
 RADIO SPEAKER CLOTH 126
 RADIO SPEAKER GRILLE 61, 127
 RADIO STATION SELECTOR 125
 RADIUS ROD 244
 RADIUS ROD BUSHING 17
 REAR AXLE 22
 REAR AXLE ASSEMBLIES (STREET ROD) 253
 REAR END COVER 178
 REAR FENDERS (FIBERGLASS) 195 to 199
 REAR QUARTER WINDOW RUBBER 184
 REAR SUSPENSION (STREET ROD) 253-256
 REAR WINDOW BUMPER 151, 154
 REAR WINDOW DRAIN 148
 REAR WINDOW SEAL 184
 REAR WINDOW STRAP 151
 REFLECTOR, HEADLAMP 75
 REGULATOR HANDLE 189
 REGULATORS (WINDOW) 181
 REGULATOR, WINDSHIELD 182
 RESISTOR 71
 RESTORATION SUPPLIES 218
 RIM LINERS 10

RING & PINION GEARS 21
 RIVETS 129
 ROADSTER TOP IRONS 151, 204
 ROCKER PANELS 139
 ROD BEARINGS 33
 ROOF RIB WOOD KITS 171
 ROTOR (DISTRIBUTOR) 71
 RUBBER (WINDSHIELD) 182
 RUMBLE BUMPERS 149, 185
 RUMBLE HANDLES 83, 150
 RUMBLE HANDLE PAD 84
 RUMBLE HINGE KITS 149
 RUMBLE LATCH 84
 RUMBLE LID SEAL 185
 RUMBLE SEAT PARTS 149, 150
 RUMBLE SEAT RAIN GUTTERS 148
 RUMBLE STEP 149
 RUMBLE STEP BRACKET 149
 RUMBLE TRIP LEVER 150
 RUNNING BOARD 95 to 97
 RUNNING BOARD BOLT 95, 134
 RUNNING BOARD BRACES 97
 RUNNING BOARD COVERS 97
 RUNNING BOARD COVER GLUE 95, 218
 RUNNING BOARD PAD 25
 RUNNING BOARD MOULDINGS 97
 RUNNING BOARD TRIM CLIP KIT 97
 RUNNING BOARDS (FIBERGLASS) 200
 RUNNING BOARD STEP PLATES 95

S

SAFETY SWITCH (NEUTRAL) 207
 SAGINAW STEERING MOUNT 208
 SCREEN, COWL VENT 138
 SCREEN, HORN 86
 SCREW, COWL LIGHT 78, 132
 SCREW, DASH 136
 SCREW, DOOR HANDLE 130
 SCREW, DOOR HINGE 131
 SCREW, DOOR SCUFF 132
 SCREW, DOVETAIL 131
 SCREW, FLOORBOARD 133
 SCREW, FRONT FENDER 134
 SCREW, HEADLAMP RIM 75, 132
 SCREW, HOODLATCH 135
 SCREW KIT, INTERIOR 130
 SCREW, RADIATOR SHELL 135
 SCREW, REAR WINDOW 134
 SCREW, TAILLIGHT 131
 SCREW, WINDSHIELD FRAME 133
 SCUFF PLATES (DOOR) 159
 SEALED BEAM HEADLAMP 73, 74
 SEALED BEAM ADJUSTMENT KIT 73
 SEAT ADJUST HANDLE 161
 SEAT, BENCH (STREET ROD) 164
 SEATS (STREET ROD) 164
 SEAT FRAME SUPPORTS 186
 SEAT RELEASE PARTS 161
 SEAT SPRINGS 165 to 168
 SEAT SPRING LOCATING PIN 186
 SEAT WOOD 170
 SENDING UNIT (GAS) 54, 211
 SENDING UNIT, TEMPERATURE 64
 SHACKLE KITS 28, 251
 SHEETMETAL, BODY CHANNEL 147
 SHEETMETAL, DECK GUTTER 148
 SHEETMETAL, FLOOR 147, 227-229
 SHEETMETAL, FLOOR EXTENSION 147, 227
 SHEETMETAL, GRILLE 44, 45, 47, 50
 SHEETMETAL, PACKAGE TRAY 147
 SHEETMETAL, PATCH PANEL 139, 140, 147
 SHEETMETAL, RUMBLE RISER 147
 SHEETMETAL, SEAT ADJUSTER 147
 SHEETMETAL, SEAT FRAME 147
 SHEETMETAL, SEAT PANEL 148
 SHEETMETAL, SEAT RISER 147
 SHEETMETAL, UNDER DECK LID 146
 SHEETMETAL, UNDER SEAT 147, 227-229
 SHEETMETAL, WINDOW DRAIN 148
 SHIFT BOOT 40, 137
 SHIFT KNOB 39, 59
 SHIFT LEVER GROMMET 39, 40
 SHIFT LINKAGE REPAIR KIT 40
 SHIFTER (STREET ROD) 215, 263
 SHIMS (FRAME) 25
 SHOCK KIT 121, 209, 249
 SHOCK LINK BALL 121
 SHOCK MOUNT 121, 251
 SHOCK ABSORBER PARTS 121
 SIDE CURTIN ROD SOCKETS 134
 SIDEMOUNT MIRROR 114
 SILL PLATE, DOOR 159
 SIGRTS 200
 SOCKET, HIGH BEAM JEWEL 84
 SPARE TIRE COVER TRIM 10, 122
 SPARE TIRE COVER SEAL 10
 SPARE TIRE GROMMET 10
 SPARE TIRE HOLD-DOWN BRACKET 122
 SPARE TIRE PAD 10

SPARK PLUGS 72
 SPARK PLUG LOOM 72, 213
 SPARK PLUG WIRES 71
 SPARK PLUG WIRE BOOT 70
 SPEAKER CLOTH 126
 SPEAKER GRILLE 61, 127
 SPEED EQUIPMENT (FLATHEAD) 42
 SPEEDOMETER CABLES 110
 SPEEDOMETER CABLE BRACKET 110
 SPEEDOMETER CABLE GROMMET 57
 SPEEDOMETER FACES 109
 SPEEDOMETER FACE GLASS 64
 SPINDLE 246, 250
 SPINDLE BOLT KITS 16, 250
 SPOTLIGHTS 123
 SPREADER BARS 26, 263
 SPRING, BRAKE/CLUTCH 11, 14, 40, 41
 SPRING, CLAMP 28, 251
 SPRING COVERS 122
 SPRING, COWL VENT 138
 SPRING, DOOR 141
 SPRING, DOOR PANEL 190
 SPRING (FRONT) 28, 213, 251
 SPRING, GLOVE BOX DOOR 154
 SPRING, HOOD ARM & LATCH 103
 SPRING, HORN BUTTON 19
 SPRING, LINER 254
 SPRING, MOUNTING KIT 212, 254
 SPRING PARTS 28, 29, 251
 SPRING PERCH 16, 212, 251
 SPRING, PERCH NUT 18
 SPRINGS (SEAT) 165 to 168
 SPRING, SHACKLE 28, 254
 SPRING, "U" BOLT 29, 254
 STABILIZER BAR 29
 STABILIZER BUSHING 29
 STABILIZER SWIVEL 16
 STARTER BUTTON 59
 STARTER PARTS 65
 STEERING ARM 250
 STEERING BOX PARTS 17 to 19
 STEERING COMPONENTS (STREET ROD) 208, 250, 252
 STEERING COLUMN 214, 252
 STEERING COLUMN DROPS 215, 252
 STEERING FLOOR PLATES 137, 178, 215
 STEERING GEAR 252
 STEERING SECTOR 18
 STEERING SHAFT BUSHING 17
 STEERING TUBE FLOOR PLATE 137
 STEERING TUBE SEALS 137, 138
 STEERING U-JOINTS 208
 STEERING WHEELS 19, 232
 STEERING WHEEL PAINT 19, 218
 STEP, RUMBLE 149
 STONE DEFLECTOR (BUMPER) 120, 204
 STONE GUARD 94
 STOP LIGHT SWITCH 80
 STRIKER PLATE, DECK 150, 189
 STRIKER PLATE, DOOR 140
 STRIKER PLATE PAD 140
 SUICIDE DOOR SAFETY LOCK 141
 SUN VISORS 160
 SUN VISOR ROD 151, 160
 SUN VISOR BRACKET 151
 SUSPENSION COMPONENTS (STREET ROD) 245-256
 SWITCH, DASH LIGHT 84
 SWITCH LEVER, IGNITION 20
 SWITCH, NEUTRAL SAFETY 207
 SWITCH, UNIVERSAL 108
 SWITCH PLATE, IGNITION 66

T

T-SHIRTS 230, 231, INSIDE BACK COVER
 TAG, FORD SCRIPT 124
 TAIL GATES 174
 TAIL GATE BUMPER 164
 TAIL LAMP BRACE 80
 TAIL LAMP BRACKETS 79, 80
 TAIL LAMP CONDUIT REPAIR 88
 TAIL LAMP HALOGEN CONVERSION 208
 TAIL LAMP LENS 81
 TAIL LAMP PAD 82
 TAIL LAMP PARTS 78 to 82
 TAIL LAMP REFLECTOR 80
 TAIL LAMP RING 80
 TAIL LAMPS 78, 79, 213
 TAIL LAMP TRIM 79
 TAIL LAMP SCREWS 131
 TAIL LAMP SOCKET 69
 TAIL LAMP WIRING 69
 TAIL PIPE 27
 TANDEM WIPER 112
 TAPE, GLASS SETTING 143
 TEMPERATURE GAUGE 64
 TEMPERATURE GAUGE HOSE FITTING 122
 TEMPERATURE SENDER 64
 THERMOSTAT 51
 THERMOSTAT HOUSING 260
 THROTTLE ASSEMBLY 56, 57, 205, 214

THROTTLE CABLE (STREET ROD) 214
 THROTTLE CABLE KITS 62
 THROTTLE RODS 56
 TIE RODS 16, 252
 TIE ROD CLAMP 127
 TIE ROD ENDS 17, 252
 TIE ROD JAM NUT 263
 TIE ROD SEAL 17
 TIRE COVERS 10
 TIRES 10
 TIRE COVER TRIM 10
 TIRE TUBES 10
 TOOL BAG 109
 TOP BOWS (OAK) 171
 TOP BOW PADS 152
 TOP BOW SEAL 145, 153
 TOP DECK MATERIAL 160
 TOP DECK RETAINER 160
 TOP HOLD-DOWN 151, 153, 154
 TOP IRONS 151, 204
 TOP IRON RIVET COVERS 151
 TOP KNOBS (CONVERTIBLE) 153
 TOP MATERIAL 160
 TOP MOULDINGS 160
 TOP REST BRACKET 153
 TOP REST SCREW 134
 TRAILING ARMS 255
 TRANSMISSION COVERS 178
 TRANSMISSION COVER FASTENER KIT 133
 TRANSMISSION MOUNT 32
 TRANSMISSION-TO-FLOOR SEAL 137
 TRANSMISSION PARTS 37 to 41
 TRANSMISSION SHIFTER 215, 263
 TRIM, BODY 102, 107
 TRIM CEMENT 158, 218
 TRIM CLIP KITS 129, 130
 TRIM, DASH 60
 TRIM, HOOD 102, 103, 106, 107
 TRIM, KICK PANEL 160
 TRIM RING (SPARE TIRE) 10
 TRIM, RUNNING BOARD 97
 TRIM SCREW KITS 129, 130
 TRUNK ARM SUPPORT 186
 TRUNK EMBLEM 83
 TRUNK GUSSETS 148
 TRUNK HANDLES 83, 84
 TRUNK HANDLE NUT 132
 TRUNK HANDLE PAD 84
 TRUNK HINGE 186
 TRUNK HINGE PADS 186
 TRUNK LATCH 84, 170
 TRUNK LID (FIBERGLASS) 203
 TRUNK LID BASE 84
 TRUNK LID BASE (INNER) 84
 TRUNK LID BUMPER 185
 TRUNK LID HINGES 186
 TRUNK LID LATCH 84, 170
 TRUNK LID SEAL 195
 TRUNK MAT 179
 TRUNK TOOL COVER (WOOD) 172
 TUBULAR STRUT ROD 248
 TURN SIGNAL KIT 78

U

U-BOLT 29, 251
 U-JOINTS 37, 208
 UPHOLSTERY BUTTONS 133
 UPHOLSTERY HOG RINGS 165
 UPPER DOOR SEAL 163

V

V-8 EMBLEM, HOOD 98
 V-8 EMBLEM, LUGGAGE RACK 124
 V-8 EMBLEM, SHELL 48, 76
 VACUUM WIPER MOTORS 110, 111
 VALVE PARTS 35
 VALVE GUIDE 35
 VENT GASKET, COWL 138
 VENT WINDOW EDGE SEAL 183, 184
 VENT WINDOW ESCUTCHEON 184, 190
 VENT WINDOW HANDLE 184, 189, 205
 VENT WINDOW REPAIR KIT 184
 VENT WINDOW RUBBER 183
 VENT WINDOW SEAL 183
 VOLTAGE CUT-OUT 63
 VOLTAGE REDUCER 63, 207
 VOLTAGE REGULATOR 63
 VOLTAGE REGULATOR PAD 63

W

WATER PUMPS 51
 WEATHERSTRIP ADHESIVE 158, 218
 WEBBING 26
 WELTING (FENDER) 93
 WHEEL BEARINGS 8 to 10

WHEEL CYLINDERS (FRONT) 12
 WHEEL CYLINDERS (REAR) 13
 WHEEL PARTS 8 to 10, 217
 WHEEL TRIM RINGS 7
 WHEEL WELLS 147, 210
 WINDLACE 162
 WINDOW CHANNEL (CONVERTIBLE) 152
 WINDOW CHANNEL (FELT) 155, 156
 WINDOW CHANNEL (METAL) 157, 159
 WINDOW CRANK 187-189, 205
 WINDOW CRANK KNOB 190
 WINDOW FELT KITS 155, 156
 WINDOW FRAME (BACK) 151, 213
 WINDOW FRAME SEAL 152
 WINDOW GLASS PATTERNS 142
 WINDOW REGULATORS 161
 WINDOW RETAINER (DOOR) 155 to 158
 WINDOW RUBBER (BACK) 184
 WINDOW RUBBER (VENT) 183, 184
 WINDOW SEAL (CONVERTIBLE) 152, 153
 WINDOW SEAL (QUARTER) 184
 WINDOW SEAL (REAR) 184
 WINDOW SHADE (BACK) 161
 WINDOW STOP 158
 WINDOW VENT, HANDLE 184, 189
 WINDSHIELD DIVISION BARS 107
 WINDSHIELD FRAME PARTS 142-144
 WINDSHIELD FRAMES 142, 213
 WINDSHIELD FRAME CLIP 143
 WINDSHIELD GARNISH MOULDING 144
 WINDSHIELD HANDLE 183
 WINDSHIELD HARDWARE 143, 144
 WINDSHIELD HINGE SEAL 182
 WINDSHIELD POST PAD 144
 WINDSHIELD REGULATOR HANDLES 183
 WINDSHIELD REGULATORS 182
 WINDSHIELD RUBBER 182
 WINDSHIELD SEAL 182
 WINDSHIELD SEALER 143
 WINDSHIELD STANCHION 143, 144
 WINDSHIELD STUD 134, 144
 WINDSHIELD SWING ARM 143
 WINDSHIELD WING NUT 144
 WINDSHIELD WIPER ARMS 112, 205
 WINDSHIELD WIPER MOTORS 110, 111
 WINDSHIELD WIPER PARTS 110 to 113
 WINDSHIELD WIPER TOWERS 113
 WINDING BRACKETS 121
 WINDING BRACKET PADS 121
 WINDING TENSION SPRING 134
 WING TIPS (BUMPER) 120
 WIPER ARMS & BLADES 112, 205
 WIPER ARM NUT 111
 WIPER MOTORS 110, 111
 WIPER SHAFT SEAL 112
 WIPER SWITCH 112
 WIPER TOWER 113
 WIPER TOWER PADS 112
 WIRE CLAMP 64
 WIRE CLIP 69
 WIRE CONNECTOR 69
 WIRE LOOM 69, 72, 213
 WIRE LOOM GROMMET 68
 WIRE PER FOOT 69
 WIRING BOARDS (STREET ROD) 262
 WIRING, CLOCK LIGHT 66
 WIRING, COIL 67
 WIRING, CONVERTIBLE TOP 66
 WIRING, COWL LIGHT 67
 WIRING, DASH 68, 206
 WIRING, DOME LIGHT 69
 WIRING, ENGINE 66, 67
 WIRING, HEADLAMP 67
 WIRING, HIGH BEAM JEWEL 84
 WIRING, HORN 86
 WIRING, HORN BUTTON 20
 WIRING, LICENSE LIGHT 69
 WIRING, OVERDRIVE 69
 WIRING, PARKING LIGHT 77
 WIRING, SPARK PLUG 71
 WIRING SYSTEM (STREET ROD) 206, 207
 WIRING, TAIL LIGHT 69
 WISHBONE SPLITTER 206
 WOOD, FLOOR BOARD 172
 WOOD, HEADER 170, 171
 WOOD, PACKAGE TRAY 171
 WOOD, ROOF RIB 171
 WOOD, SEAT FRAME 170
 WOOD, WINDOW FRAME 171
 WOOD, WINDSHIELD STRIP 171
 WORM GEAR (STEERING) 17

X

X-MEMBER SUPPORT 212

HUBCAPS

THESE HUBCAPS REPRESENT SOME OF THE FINEST EXAMPLES WE HAVE SEEN OF REPRODUCTION MANUFACTURING.

THE EARLY HUBCAPS (1932-1935) HAVE STAINLESS STEEL OUTER SHELLS AND STEEL INNER LINERS AS ORIGINALLY MANUFACTURED.

MOST OF THE LATER MODEL HUBCAPS ARE ALL STAINLESS STEEL AS ORIGINALLY MANUFACTURED.

THEY ARE ALL HIGHLY POLISHED TO A MIRROR-LIKE SURFACE AND COME WITHOUT PAINTED DETAILS.



18-1130-P
1932-TYPE WITH
PLAIN CENTER
\$30.00 EACH

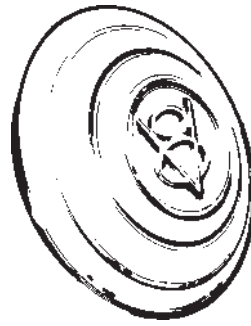

18-1130
1932 V8
PASSENGER & PICKUP
\$30.00 EACH

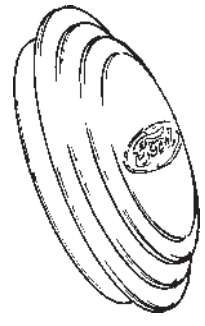

B-1130-A
'32-'33 FOUR CYLINDER
PASSENGER & PICKUP
\$30.00 EACH

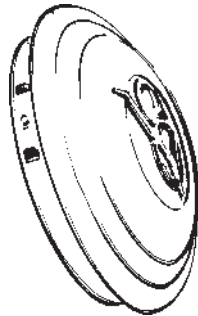

40-1130-A
1933 V8
PASSENGER & PICKUP
\$30.00 EACH



40-1130-B
1934 V8
PASSENGER & PICKUP
\$30.00 EACH

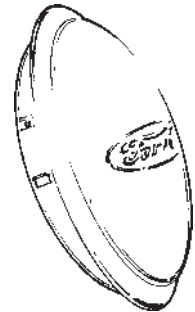

40-1130-C
1934 4 CYLINDER
PASSENGER & PICKUP
\$30.00 EACH

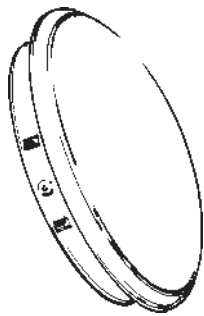

40-1130-P
1934 PLAIN CENTER
FITS 1932-35
\$30.00 EACH

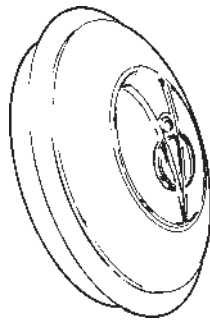

48-1130
1935
PASSENGER & PICKUP
\$30.00 EACH

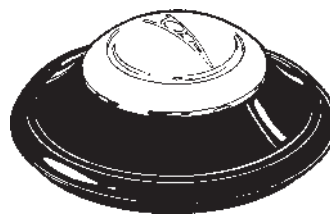

68-1130
1936 PASSENGER
\$55.00 EACH

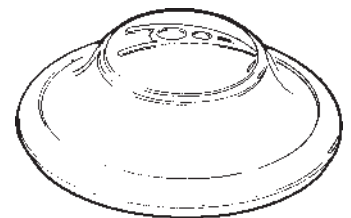

78-1130
1937 PASSENGER
\$ INQUIRE



81A-1130
1938 PASSENGER DLX
\$ INQUIRE

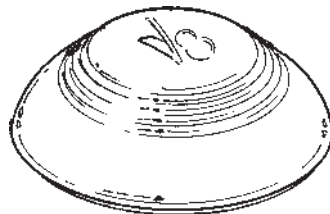

91A-1130
1939 PASSENGER DLX
\$ INQUIRE

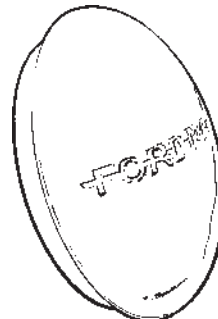

01A-1130
1940 DELUXE
\$40.00 EACH

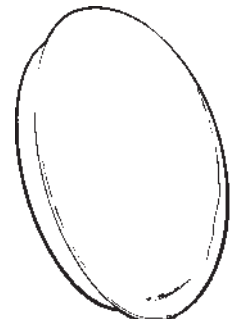

01A-1130-BM
1940 BABY MOON
\$35.00

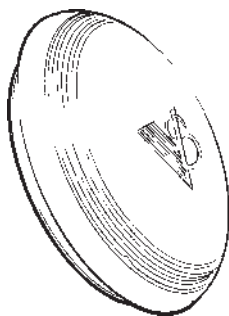

01C-1130
1940 STANDARD
PASSENGER & PICKUP
\$40.00 EACH

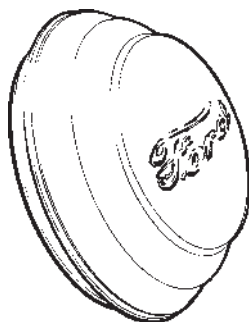

11A-1130
1941 PASSENGER
'41-'42 PICKUP
\$40.00 EACH

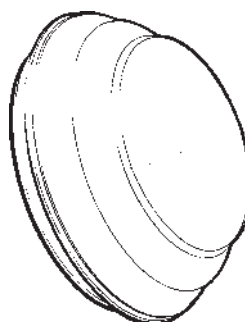

11A-1130-BM
1941 BABY MOON
\$35.00 EACH

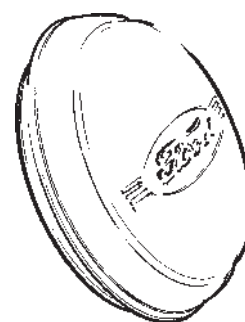

21A-1130
1942 PASSENGER
1946 PICKUP
\$40.00 EACH

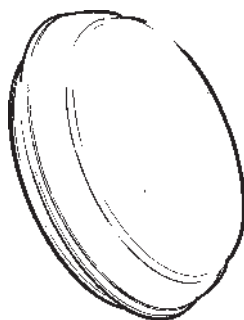

21A-1130-BM
1942-48 BABY MOON
\$35.00

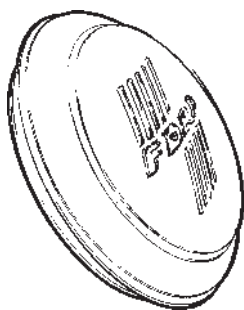

51A-1130
1946 PASSENGER
\$40.00

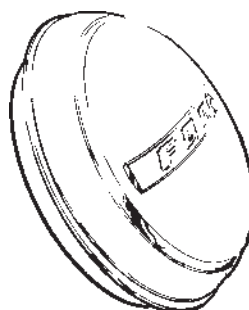

6A-1130
1947-1948 PASSENGER
1947-1956 PICKUP
\$40.00 EACH

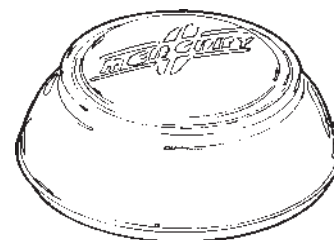

99A-1130
1939 MERCURY
INQUIRE

BEAUTY RINGS

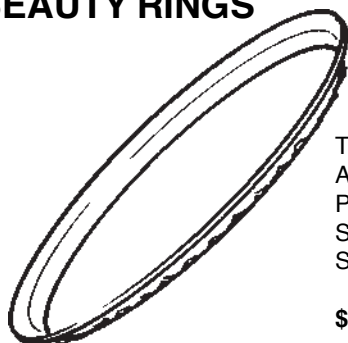

THESE BEAUTY RINGS ARE ALL STAINLESS STEEL AND POLISHED TO A MIRROR-LIKE SURFACE. SPECIFY SIZE AND STYLE.

\$35.00 EACH

01A-18303-14 14 INCH, FOUR RIB PATTERN

01A-18303-15 15 INCH, FOUR RIB PATTERN

01A-18303-16 16 INCH, FOUR RIB PATTERN AS ORIGINAL

6A-18303-14 14 INCH, SMOOTH CONTOUR

6A-18303-15 15 INCH, SMOOTH CONTOUR

6A-18303-16 16 INCH, SMOOTH CONTOUR

INNER BEAUTY RINGS

FITS SNUGGLY AROUND HUBCAP. IN CONJUNCTION WITH ABOVE BEAUTY RING FORMS A FULL STAINLESS STEEL WHEEL COVER. FITS ONLY 16" WHEEL.

01A-18331
SET OF 4

225.00

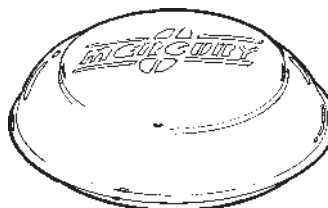

19A-1130
1941 MERCURY
INQUIRE



59A-1130
1947-1948 MERCURY
\$85.00 EACH

WIRE WHEEL

ADAPTER RINGS

THESE RINGS ADAPT 1932-35 FORD HUBCAPS TO FIT CADILLAC, CHRYSLER, T-BIRD, AND TRUE CLASSIC, SHARP, OR McLEAN WIRE WHEELS.

CADILLAC B-1130 CD

CHRYSLER 6-7/16 HOLE B-1130 CY

T-BIRD 6-3/16 HOLE B-1130 TB

TRUE CLASSIC
McLEAN SHARP B-1130 MC
6-5/16 HOLE IN ORIGINAL WHEEL

SET OF 4

\$40.00

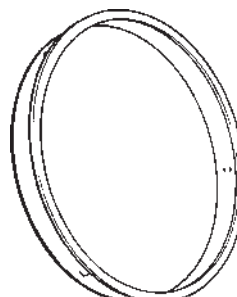

WHEELS SOLIDS

SOLIDS ARE NEWLY MANUFACTURED WHEELS PROVIDING VINTAGE APPEARANCE AND LATE MODEL BOLT PATTERNS. THE ORIGINAL FORD BOLT PATTERN IS ALSO AVAILABLE AS A SPECIAL ORDER ITEM.

WE OFFER A WIDE SELECTION OF WIDTHS AND OFFSETS AS WELL AS A PLAIN OR CHROME OUTER RIM OPTION. CENTERS AVAILABLE SOLID OR VENTED.

SEE PAGE 217

WHEEL PARTS HUB BOLTS AND NUTS



HUB BOLT NUT
1932-48 PASSENGER & COMMERCIAL
B-1012 EACH

.95



CUPPED LUG-NUT WASHERS -STAINLESS
FOR WORN WHEEL LUG HOLES
KEEP PAINT FROM CHIPPING

1932-48
B-1013 EACH

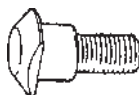

WHEEL HUB BOLT, .62" DIA.
1932-35
B-1107 EACH

1.00

WHEEL HUB BOLT, .56" DIA.
1936-48
68-1107 EACH

3.00

WHEEL HUB BOLT
1940-48 PASSENGER & 1/2 TON TRUCK, .56" DIA.
01A-1107 EACH

3.00

WHEEL HUB BOLT
1940-48 PASSENGER & 1/2 TON TRUCK, .62" DIA.
51A-1107 EACH

3.00

WHEEL HUB BOLT FOR NEW DRUMS FRONT
610-234 EACH

3.50

REAR
610-364 EACH

3.50

USE OUR TOLL FREE
ORDER NUMBER:
1-800-532-1932

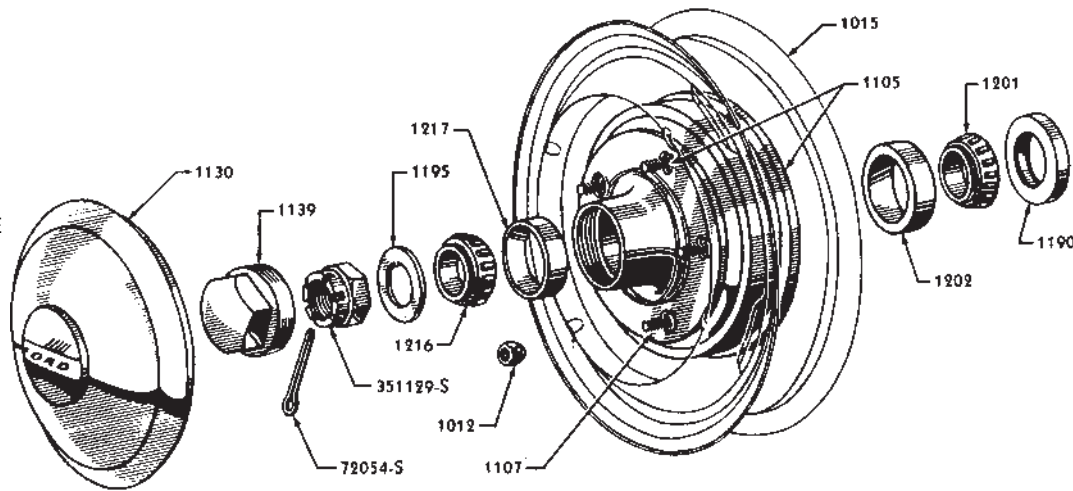

PASSENGER FRONT WHEEL HUB, BEARING, CAP, ETC.

BRAKE DRUMS

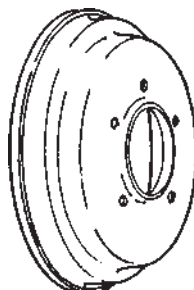

BRAKE DRUM

1940-48 PASSENGER / PU
(HUB FITS INSIDE/BEHIND DRUM)
21A-1125 EA.CH 135.00

1942-48 PASSENGER / PU
(HUB FITS OUTSIDE/IN FRONT OF DRUM)
51A-1125 EA.CH 135.00



WIRE WHEEL SUPPORT PLATE
FOR 1928-35 WIRE WHEELS USING 1940-48 HYDRAULIC BRAKE DRUMS
B-1015-SP SET OF 4 95.00

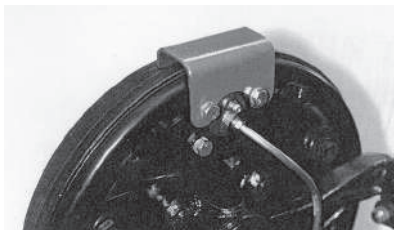

1932-48 BRAKE DRUM RETAINER
RETAINS DRUM & WHEEL IF AXLE FAILS
MOUNTING BOLTS INCLUDED
B-1125-R SET OF TWO 29.95

FRONT HUB DUST CAP
1932-36, THREADED
B-1139 EACH 6.75

1936-42, THREADED
68-1139 EACH 6.75

1942-48, PRESS-IN
51A-1139 EACH 6.75

1939-48 TRUCK
91T-1139 EACH INQUIRE

WHEEL BEARINGS & SEALS



REAR WHEEL GREASE SEAL

1932-36, PASSENGER & COMMERCIAL B-1175 EACH	4.95
1932-34, BIG TRUCK BB-1175-A EACH	12.95
1934-48, BIG TRUCK BB-1175-C EACH	59.50
1937-48, PASSENGER & COMMERCIAL 78-1175 EACH	5.95
1939-47, 3/4 TON TRUCK 91D-1175 EACH	INQUIRE
1938-47, 1 TON TRUCK 61-1175 EACH	INQUIRE



REAR WHEEL SEAL SNAP RING

1932-36, PASSENGER & COMMERCIAL B-1180 EACH	2.00
1937-48, PASSENGER & COMMERCIAL 78-1180 EACH	2.00

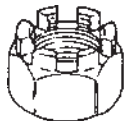

REAR HUB AXLE NUT 1932-48 PASSENGER & COMMERCIAL B-4242 EACH	2.00
---	------

REAR HUB GASKET 1932-48, PASSENGER & COMMERCIAL B-4244 PAIR	2.00
--	------

REAR HUB WASHER 1932-48 PASSENGER & COMMERCIAL B-4244-W (351505-S18) EACH	1.00
--	------

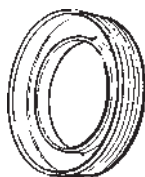

FRONT WHEEL GREASE SEAL

1932-34, PASSENGER & COMMERCIAL B-1190 EACH	5.95
1935-48, PASSENGER & COMMERCIAL 48-1190 EACH	4.50
1938, BIG TRUCK 81T-1190 EACH	INQUIRE
1939-48, BIG TRUCK 91T-1190 EACH	9.50
1940-47, 1 TON TRUCK 01Y-1190 EACH	5.95



FRONT AXLE SPINDLE NUT

1932-48, PASSENGER & COMMERCIAL B-1193 (351125-S) EACH HYDRAULIC BRAKES 68-1193 (351129-S) EACH	2.50 4.95
--	--------------



FRONT HUB GREASE RETAINING WASHER

1932-48, PASSENGER & COMMERCIAL B-1195 EACH	1.50
--	------



FRONT WHEEL INNER BEARING

1932-48, PASSENGER & COMMERCIAL B-1201 EACH TIMKEN: B-1201-TIM EACH	9.00 16.50
1930-37, BIG TRUCK BB-1201 EACH	24.95
1938, BIG TRUCK 81T-1201 EACH	29.95
1940-47, 1 TON TRUCK 01Y-1201 EACH	22.50
1939-47, BIG TRUCK 68-4221 EACH	46.50



FRONT WHEEL INNER RACE

1932-48, PASSENGER, COMMERCIAL B-1202 EACH TIMKEN: B-1202-TIM EACH	8.00 13.00
1930-37, BIG TRUCK BB-1202 EACH	17.95
1938, BIG TRUCK 81T-1202 EACH	17.95
1940-48, 1 TON TRUCK 01Y-1202 EACH	8.50
1937-47 BIG TRUCK 68-4222 EACH	21.75

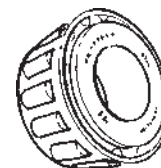

FRONT WHEEL OUTER BEARING

1932-48, PASSENGER & COMMERCIAL B-1216 EACH TIMKEN B-1216-TIM EACH	13.00 23.00
1930-37, BIG TRUCK BB-1216 EACH	24.95
1938, BIG TRUCK 81T-1216 EACH	32.95
1939-47, BIG TRUCK 91T-1216 EACH	19.95



FRONT WHEEL OUTER RACE

1932-48, PASSENGER & COMMERCIAL B-1217 EACH TIMKEN: B-1217-TIM EACH	5.00 10.75
1932-37, BIG TRUCK BB-1217 EACH	18.95
1938, BIG TRUCK 81T-1217 EACH	18.95
1939-47, BIG TRUCK B-1202 EACH	7.00

WHEEL BEARINGS & SEALS (CONT'D)

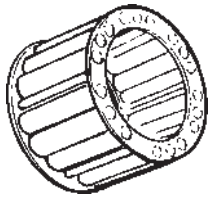

REAR WHEEL BEARING

1932-36, PASSENGER & COMMERCIAL B-1225-A EACH	35.00
SLEEVE FOR 28-36 -USE BEARING 68-1225 68-1236 EACH	39.95
1932-34, BIG TRUCK BB-1225-A EACH	INQUIRE
1934-47, BIG TRUCK OUTER BEARING BB-1240 EACH	32.50
1934-47, BIG TRUCK INNER BEARING BB-4221-B EACH	33.50
1937-48, PASSENGER & COMMERCIAL 68-1225 EACH	65.00
1938-47, 1 TON TRUCK OUTER BEARING 61-1240 EACH	32.50
1938-47, 1 TON TRUCK INNER BEARING 61-4221 EACH	22.00
1939-47, 3/4 TON TRUCK OUTER BEARING 91D-1240 EACH	29.50
1939-47, 3/4 TON TRUCK INNER BEARING 91D-1244 EACH	27.25



REAR WHEEL BEARING RACE

1934-47, BIG TRUCK OUTER RACE BB-1239 EACH	INQUIRE
1934-47, BIG TRUCK INNER RACE BB-4222 EACH	INQUIRE
1938-47, 1 TON TRUCK OUTER RACE 61-1239 EACH	17.50
1938-47, 1 TON TRUCK INNER RACE 61-4222 EACH	15.00
1939-47, 3/4 TON TRUCK OUTER RACE 91D-1239 EACH	15.95
1938-47, 3/4 TON TRUCK INNER RACE 91D-1243 EACH	14.95

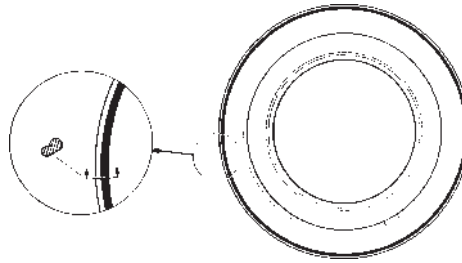

SPARE TIRE COVER TRIM RING STAINLESS STEEL

1933-34, PASSENGER 40-1350 EACH	110.00
1935-36, PASSENGER 48-1350 EACH	110.00

1932-36 PASSENGER & 32-48 STATION WAGON SPARE-TIRE-COVER RUBBER SEAL

B-18302-K EACH	8.50
----------------	------

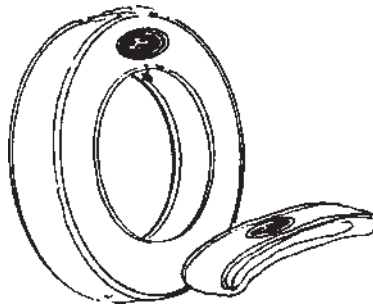

FORD SCRIPT TIRE COVERS

BLACK 5.25X18 B-1395-A EACH	44.50
5.50X17 40-1395-A EACH	44.50
6.00X16 48-1395-A EACH	44.50
TAN 5.25X18 B-1395-B EACH	44.50
5.50X17 40-1395-B EACH	44.50
6.00X16 48-1395-B EACH	44.50



SIDEMOUNT TIRE ARM GROMMET

1932, PASSENGER & COMMERCIAL B-1410, EACH	5.00
--	------

TIRES

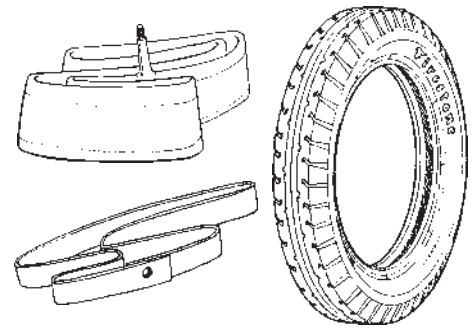

TIRES



TIRE PRICES CONSTANTLY CHANGE PLEASE CALL FOR A CURRENT PRICE

1932 550X18 BLACK WALL 18-1500-FA EACH	133.00
WHITE WALL 18-1500-FBW EACH	164.00
1933-34 525/550X17 BLACK WALL 40-1500-FA EACH	126.00
WHITE WALL 40-1500-FBW EACH	166.00
1935-48 600X16 BLACK WALL 48-1500-FA EACH	133.00
WHITE WALL 48-1500-FBW EACH	159.00
1949-56 670X15, WIDE WHITE WALL 8A-1500-FBW EACH	152.00

TIRE INNER TUBES

550X18 B-1505 EACH	19.95
5.50X17 40-1505 EACH	19.95
6.00X16 48-1505 EACH	19.95

ASK ABOUT TRUCK TIRES

RIM LINER

1932-48, PASSENGER & COMMERCIAL B-1024 EACH	2.95
--	------

BRAKE PARTS

USE OUR 800 NUMBER OR FAX NUMBER FOR PLACING YOUR ORDER!

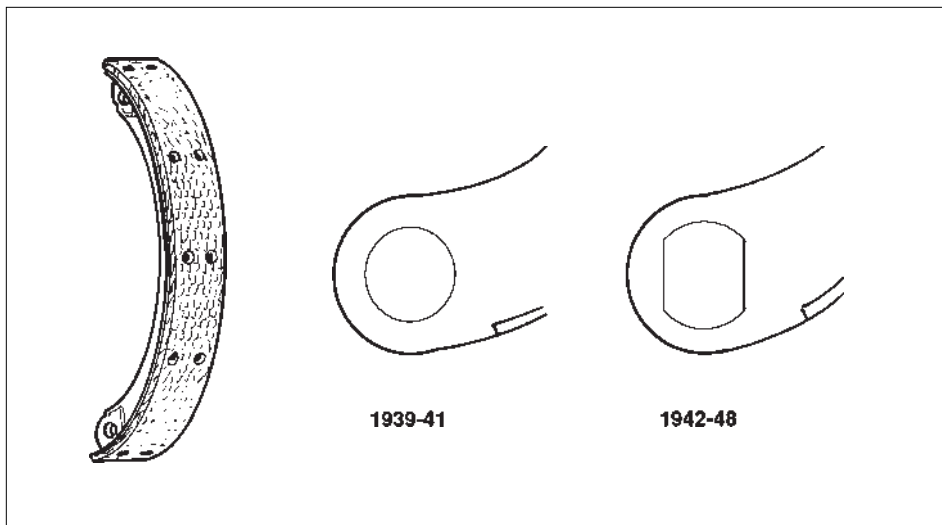

LINED BRAKE SHOES WITH ROUND CAM
1939-45 PASSENGER & COMMERCIAL
01A-2001 4 PC. SET (EXCHANGE) 60.00

LINED BRAKE SHOES WITH OVAL CAM
1946-48, PASSENGER & COMMERCIAL
51A-2001-S 4 PC. SET (EXCHANGE) 60.00

CORE CHARGE 15.00 PER SHOE



MASTER CYLINDER REPAIR KIT

1939-48, PASSENGER & COMMERCIAL
91A-2004 EACH 15.00

1939-48, 1 TON & 2 TON TRUCK
91T-2004 EACH 16.95

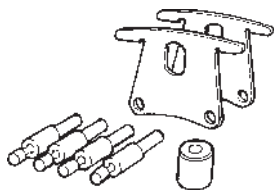

FRONT BRAKE ROLLER TRACK KIT
1932-34, PASSENGER & COMMERCIAL
B-2011-C KIT 49.95

WE HAVE PARTS NOT LISTED IN THIS CATALOG. IF YOU DO NOT SEE THE PART YOU ARE LOOKING FOR, PLEASE CALL!

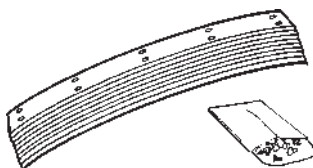

BRAKE LINING & RIVET SET

1932-34, PASSENGER & COMMERCIAL
40-2018 4 WHEEL SET (WOVEN) 115.00

1935-38, PASSENGER & COMMERCIAL
48-2018 4 WHEEL SET 115.00



BRAKE SHOE ROLLER

1928-34, PASSENGER & COMMERCIAL
B-2023 EACH 1.50

1935-36, PASSENGER & COMMERCIAL
48-2023 EACH INQUIRE

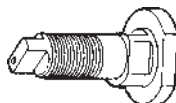

BRAKE SHOE ANCHOR PIN

1939-45, PASSENGER & COMMERCIAL
91A-2027 EACH 5.00



BRAKE SHOE CAM

1939-45, PASSENGER & COMMERCIAL
91A-2028-A EACH 4.75

1946-48, PASSENGER & COMMERCIAL
51A-2028 EACH 4.50



BRAKE SHOE ANCHOR PIN PLATE

1939-45
91A-2030 EACH 2.50

1946-48
51A-2030 EACH 6.00

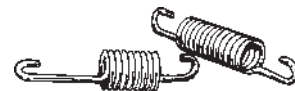

BRAKE SHOE SPRING

1928-34, PASSENGER & COMMERCIAL
B-2035 EACH 5.00

1935-36, PASSENGER & COMMERCIAL
48-2035 EACH 5.00

1939-48, PASSENGER & COMMERCIAL
91A-2035 EACH 5.00

1939-48, 1 TON & 2 TON TRUCK
92Y-2035 EACH 5.00

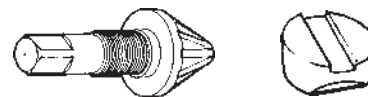

BRAKE ADJUSTING WEDGE

1928-36 PASSENGER & COMMERCIAL
B-2041 EACH 13.50

1937-38, PASSENGER & 1/2 TON TRUCK
78-2041 EACH 10.00



BRAKE LINK

1928-34, PASSENGER & 1/2 TON TRUCK
B-2042 EACH 7.50

1935, PASSENGER & 1/2 TON TRUCK
48-2042 EACH 7.50

1936, PASSENGER & 1/2 TON TRUCK
68-2042 EACH 7.50

1937-38, PASSENGER & 1/2 TON TRUCK
78-2042 EACH 7.50

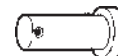

BRAKE SHOE ROLLER PIN

1932-34, PASSENGER & COMMERCIAL
B-2045 EACH .95

1935-36, PASSENGER & COMMERCIAL
48-2045 EACH 1.25

SEE PAGES 219-226 FOR BOOKS.

BRAKE PARTS (CONT'D)



BRAKE WEDGE

1932-34, PASSENGER & COMMERCIAL
B-2050 EACH 18.00

1935-36, PASSENGER & COMMERCIAL
48-2050 EACH 11.95

1936-37, PASSENGER & COMMERCIAL
68-2050 EACH 11.95

1935-36, BIG TRUCK
51-2050 11.95



FRONT BACKING PLATE BOLT

1937-48, PASSENGER & COMMERCIAL
59A-2056 EACH 4.00

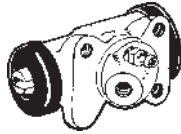

FRONT WHEEL CYLINDER

1942-48, PASSENGER & COMMERCIAL **R.H.**
21A-2061 EACH 47.50

1942-48, PASSENGER & COMMERCIAL **L.H.**
21A-2062 EACH 47.50

ABOVE CYLINDERS ALSO FIT 1939-41, BUT
MUST BE USED IN PAIRS DUE TO PISTON
SIZE CHANGE.



BRASS BRAKE CONNECTOR, REAR "TEE"

1939-47 PASSENGER & COMM.
91A-2074 EACH 13.50

1941-48 PASSENGER & COMM
99A-2074 EACH 9.50

1939 TRUCKS EXCEPT 122"
91T-2074-A EACH INQUIRE

1939 122" TRUCKS
92Y-2074-A EACH INQUIRE

1942-47 COMM, 1940-47 TRUCKS
01T-2074-A EACH INQUIRE



BRAKE SHOE RETAINER CLIPS

1939-45 PASSENGER
91A-2125 EACH 5.00

1946-48 PASSENGER
51A-2125-B EACH 10.00



BRAKE OPERATING PIN

1932-34 PASSENGER & COMMERCIAL
B-2075 EACH INQUIRE

1930-34 TRUCKS
BB-2075 EACH INQUIRE

1935-36, PASSENGER & COMMERCIAL
48-2075 EACH INQUIRE

1935-36, BIG TRUCK
51-2075 EACH INQUIRE

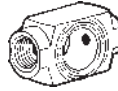

FRONT BRAKE PIPE FITTING

1939-48, PASSENGER, 39-41 COMM.
91A-2075 EACH 9.50



FRONT BRAKE OPERATING SHAFT

1932-34 PASSENGER & COMMERCIAL
B-2076 **R.H.** EACH 29.95

B-2077 **L.H.** EACH 29.95

1933-34 TRUCKS
BB-2076 **R.H.** EACH INQUIRE

BB-2077 **L.H.** EACH INQUIRE

1935-36 **R.H.** PASSENGER & COMM
48-2076 EACH 17.95

1935-36 **L.H.** PASSENGER & COMM
48-2077 EACH 17.95

1935-37 TRUCK
51-2076 **R.H.** EACH INQUIRE

51-2077 **L.H.** EACH INQUIRE



MASTER CYLINDER OUTLET FITTING

1939-40, PASSENGER & COMMERCIAL
91A-2076 EACH 10.50

1939-47 (COMM 42-47)(TRUCKS 39-47)
91T-2076 EACH INQUIRE

1939-48 (PASS 39-48) (COMM 39-48)
99A-2076 EACH 13.50

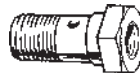

MASTER CYLINDER BOLT

1939-48, PASSENGER, 39-47 COMM.
91A-2077 EACH 7.00

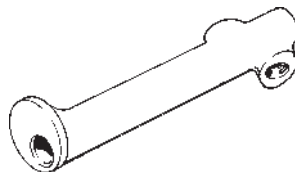

BRAKE OPERATING PIN HOUSING

1932-34, PASSENGER & COMMERCIAL
B-2078 EACH INQUIRE

1935-36, PASSENGER & COMMERCIAL
48-2078 EACH INQUIRE



REAR BRAKE HOSE

1939-48, PASSENGER & COMMERCIAL
91A-2078 EACH 15.00

1940-47, TRUCK, 1942-47 COMMERCIAL
01T-2078 EACH 20.00

FRONT BRAKE HOSE

1939-48, PASSENGER & COMMERCIAL
99A-2079 16" EACH 17.50

1939-48, PASSENGER & COMMERCIAL
91A-2079 18" EACH 19.95



FRONT CYLINDER INLET CONNECTOR

1939-41, PASSENGER & COMMERCIAL
91A-2080 EACH 13.50

1939-48, TRUCK
91T-2080 EACH INQUIRE



FRONT BRAKE LEVER DUST RING

1932, PASSENGER & COMMERCIAL
B-2087 PAIR 1.50



EMERGENCY CABLE GROMMET

1941-48, PASSENGER
11A-2091 EACH 5.00



HAND BRAKE LEVER PIN RETAINER

1939-48
91A-2106 EACH .95



HAND BRAKE LEVER PIN

1939-48, PASSENGER & COMMERCIAL
91A-2105 EACH 1.95

1939-46, PASSENGER & COMMERCIAL
91A-2107 EACH 1.95

1946-48, PASSENGER & COMMERCIAL
51A-2107 EACH 1.95



HAND BRAKE CABLE EQUALIZER

1939-48, PASSENGER, 39-47 COMM.
91A-2119 EACH 6.50

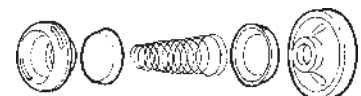

REAR WHEEL CYLINDER KIT

1939-48, PASSENGER, 39-47 COMM.
91A-2128 EACH 7.50

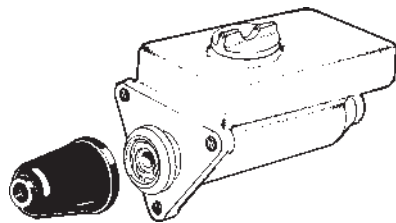

MASTER CYLINDER

1939-48, PASSENGER, 39-47 COMM.
91A-2140 EACH 95.00

1939-48, 1 TON & 2 TON TRUCK
91T-2140 EACH 95.00

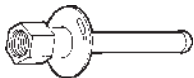

MASTER CYLINDER PUSH ROD

1939-48, PASSENGER, 39-47 COMM.
91A-2143 EACH 23.50

1939-48, 1 TON & 2 TON TRUCK
91T-2143 EACH 15.75



BOLT, FRONT LINE CONNECTOR

1939-48 PASSENGER
91A-2150 EACH 8.50



BRAKE LINE GASKET

91A-2149 EACH 1.00

MASTER CYLINDER OUTLET GASKET

1939-48, PASSENGER & COMMERCIAL
.61" I.D. 1 REQ"D
91A-2151 EACH 1.00

.51" I.D. 1 REQ"D
91A-2152 EACH 1.00



MASTER CYLINDER FILLER CAP

1939-48, ALL
91A-2162 EACH 17.00

MASTER CYLINDER FILLER CAP GASKET

1939-48, ALL
91A-2167 EACH 2.00



MASTER CYLINDER RUBBER BOOT

1939-48, PASSENGER & COMMERCIAL
91A-2180 EACH 2.95



MASTER CYLINDER BLEEDER SCREW

1939-48, PASSENGER & COMMERCIAL
8M-2208 EACH 3.00

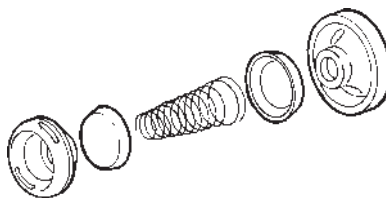

FRONT WHEEL CYLINDER REPAIR KIT

1939-41, PASSENGER & COMMERCIAL
91A-2221 EACH 10.00

1942-48, PASSENGER, 42-47 COMM.
21A-2221 EACH 10.00



REAR BACKING PLATE BOLT

1936-48, PASSENGER
1.76"
59A-2248 EACH 5.00

1937-48, PASSENGER
1.12"
59A-2249 EACH 5.00

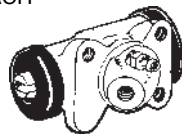

REAR WHEEL CYLINDER ASSEMBLY

1939-48, PASSENGER, 39-47 COMM. R.H.
91A-2261 EACH 47.50

1939-48, PASSENGER, 39-47 COMM. L.H.
91A-2262 EACH 47.50

1939-47, FRONT, 2 TON TRUCK, REAR
1 TON
92Y-2261 EACH INQUIRE

1939-47, REAR, 2 TON TRUCK, EXCEPT
1 TON
91T-2261 EACH INQUIRE

ASK ABOUT OTHER TRUCK WHEEL CYLINDERS



BRAKE LINES, 1/4" STEEL TUBING WITH 2 FITTINGS

8"
91A-2265-BAA EACH 4.00

12"
91A-2265-BA EACH 4.00

20"
91A-2265-BB EACH 5.00

30"
91A-2265-BC EACH 5.50

40"
91A-2265-BD EACH 6.00

51"
91A-2265-BE EACH 8.00

60"
91A-2265-BF EACH 9.00

72"
91A-2265-BG EACH 10.00

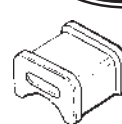

HAND BRAKE CABLE GROMMET ON REAR RADIUS ROD

1939-40, PASSENGER & COMMERCIAL
91A-2271 PAIR 6.00

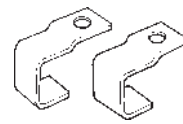

CABLE GROMMET BRACKET AT RADIUS ROD

1939-40, PASSENGER & COMMERCIAL
91A-2272 PAIR 8.00



HAND BRAKE CABLE GROMMET

1939-40 PASSENGER, 39-41 PICKUP
91A-2273-A EACH 2.00



HAND BRAKE CABLE SPRING RETAINER

1939-48 PASSENGER, '39-41 COMMERCIAL
91A-2113 EACH 3.50



HAND BRAKE CABLES

(WHEEL TO WHEEL)
1939-41, PASSENGER, 122"
91A-2275-B EACH 30.00

1941-48, PASSENGER, 106.25"
21A-2275 EACH 30.00



REAR BRAKE CABLE

1942-47, 1/2 TON TRUCK, 2 REQ'D
21C-2275 EACH 37.95



PARKING BRAKE CABLE CLIP

1939 PASSENGER & COMM., 45-47 COMM.
91A-2279 EACH INQUIRE



MASTER CYLINDER ACCESS HOLE COVER

1939-48, ALL
91A-7011136 EACH 6.50

BRAKE PARTS (CONT'D)

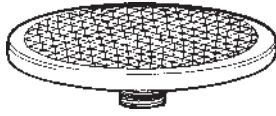

BRAKE AND CLUTCH PEDAL PAD
 PYRAMID DESIGN RUBBER
 1932, ALL
 B-2454 EACH 35.00

1933-36, ALL
 40-2454 EACH 10.00

1937-40, ALL
 78-2454 EACH 10.00

ROUND RING DESIGN (BULLSEYE)
 1941-48, ALL
 11A-2454 EACH 10.00
 TRUCK - 1941-56 (LARGE DIAMETER)
 7RT-2454 EACH 15.00



BRAKE PEDAL RETRACTING SPRING
 1932, PASSENGER & COMMERCIAL
 B-2456 EACH 15.00

1933-34, PASSENGER & COMMERCIAL
 40-2456 EACH 15.00

1937-38, PASSENGER & COMMERCIAL
 78-2456 EACH 15.00

1939, PASSENGER & COMMERCIAL
 91A-7523 EACH 6.00

1940 PASSENGER, 40-41 PICKUP
 01A-2456 EACH 6.00

1939-47, 2 TON TRUCK
 91T-2462 EACH 6.00

1941-48, PASSENGER
 99A-7523 EACH 6.00

1940-47, COMMERCIAL
 01T-2472 EACH 6.00



BRAKE ROD CLEVIS PIN
 1932-36, ALL (5/16" DIA.)
 B-2460 EACH .30
 OVERSIZE
 B-2460-OS EACH .35

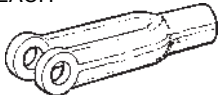

BRAKE ROD ADJUSTABLE CLEVIS
 FORK STYLE
 1932-36, ALL
 B-2461 EACH 2.95



PEDAL TO MASTER CYLINDER ROD
 1939-48, PASSENGER, 39-41 COMM.
 91A-2462 EACH 8.00

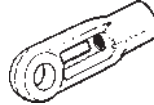

BRAKE ROD ADJUSTABLE CLEVIS
 SINGLE EYE HOLE
 1932-35, PASSENGER, COMM., 32-37 TRUCK
 BB-2466 EACH 3.50

1935-36, PASSENGER & COMMERCIAL
 48-2466 EACH INQUIRE



PEDAL ASSEMBLY BUSHING
 1935-38 PASSENGER, COE 38-47
 48-2470 EACH 50.00



BRAKE RETURN SPRING
 1935-36, PASSENGER & COMMERCIAL
 48-2472 EACH 7.00



CLUTCH & BRAKE ARM BUMPERS
 1932-34
 B-35184 PAIR 6.00

1935-38
 48-700386 PAIR 5.00



CLUTCH AND BRAKE PEDAL WEATHER SEALS
 1939-48, PASSENGER, 39-41 COMM.
 91A-2476/7527 PAIR 8.00

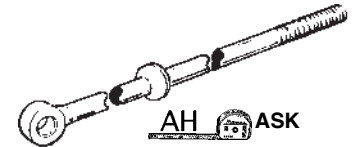

MECHANICAL BRAKE RODS

FRONT
 1932-34, PASSENGER & COMMERCIAL
 40-2495 EACH 25.00

1935-36, PASSENGER & COMMERCIAL
 48-2495 EACH 25.00

REAR
 1932, PASSENGER & COMMERCIAL
 18-2499 EACH 25.00

1933-34, PASSENGER & COMMERCIAL
 40-2499 EACH 25.00

1935-36, PASSENGER & COMMERCIAL
 48-2499 EACH 25.00

ASK ABOUT TRUCK BRAKE RODS



MECHANICAL BRAKE CABLES
 1937-38, PASSENGER, FRONT
 78-2494 EACH 39.95

1937-38, PASSENGER, REAR
 78-2498 EACH 39.95



MECHANICAL BRAKE ROD ANTI-RATTLERS

1932 PASSENGER & COMMERCIAL
 FRONT
 B-2502 PAIR 20.00
 REAR
 B-2503 EACH 11.00
 1933-34, PASSENGER & COMMERCIAL
 40-2503 EACH 11.00

1935-36, PASSENGER & COMMERCIAL
 FRONT
 48-2502 EACH 10.00
 REAR
 48-2503 EACH 11.00



EMERGENCY CABLE BOOT
 1939-48, PASSENGER & COMMERCIAL
 91A-2597 PAIR 10.00

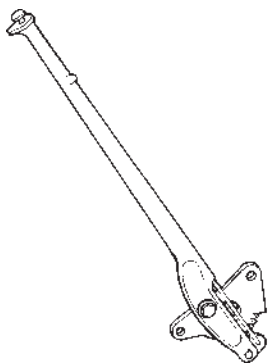

EMERGENCY BRAKE HANDLE
 CHROME PLATED
 1932, PASSENGER, COMM., 32-34 TRUCK
 WITH RATCHET
 A-2780-C EACH 87.50
 1933-34, PASSENGER & COMMERCIAL
 WITHOUT RATCHET
 40-2780 EACH 83.50

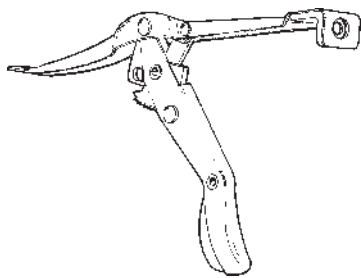

EMERGENCY BRAKE HANDLE ASSEMBLY
 1937-48, PASSENGER
 59A-2780 EACH (NEW & USED) INQUIRE



EMERGENCY BRAKE PAWL
 1939-46, PASSENGER
 91A-2786-B EACH 4.50



EMERGENCY BRAKE SECTOR
 1939-40, PASSENGER, 39-47 COMM.
 91A-2790 EACH 10.00



EMERGENCY BRAKE TENSION SPRING
 1939-47, TRUCK
 B-2793 EACH INQUIRE

1938-42, PASSENGER, 38-41 COMM.
 81A-2793 EACH 2.50

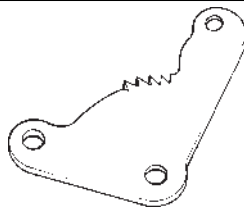

EMERGENCY BRAKE RATCHET
 1932 PASSENGER
 B-2795-B EACH INQUIRE



BRAKE HOSE & HAND BRAKE CABLE CLIP
 1937-48
 78-2814-A EACH 1.50



HAND BRAKE CABLE ASSEMBLY
 1937 PICKUP
 77-2853 EACH INQUIRE

1937-38, PASSENGER, 60"
 78-2853-A EACH 39.95

1940-41, PASSENGER, 77"
 01A-2853 EACH 39.95

1939, PASSENGER, 39-41 PICKUP
 01C-2853 EACH 39.95

1940-41, 1 TON TRUCK
 01Y-2853 EACH INQUIRE

1942-47, 1/2 TON & COMM.
 21C-2853 EACH 47.50

1941-48, PASSENGER, 85.5"
 11A-28.53 EACH 39.95

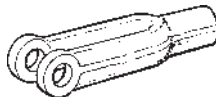

EMERGENCY BRAKE CABLE ADJUSTING CLEVIS
 1937-38 PASSENGER & COMMERCIAL
 78-2484 EACH 35.00
 1939-40 PASSENGER
 91A-2484 EACH NOT AVAILABLE
 1941-48 PASSENGER
 11A-2484 EACH 35.00
 1939-47 COMMERCIAL
 92Y-2484 35.00

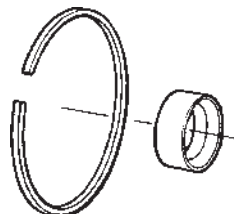

HYDRAULIC BRAKE ADAPTER KIT
 ADAPTS 1939-48 BACKING PLATES TO
 FIT 1932-36 SPINDLES
 X-2000 4 PIECE KIT 20.00



GREASE FITTINGS - ORIGINAL STYLE
 5/16" STRAIGHT DRIVE-IN FITTING
 A-353026 EACH .75

3/8" THREADED FITTING
 A-353027 EACH .75

25 DEGREE FITTING FOR FRONT END
 A-353029 EACH 1.50

67 1/2 DEGREE FITTING FOR FRONT
 END
 A-353031 EACH 1.75

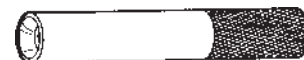

GREASE FITTING DRIVER
 X-352001 EACH 5.50

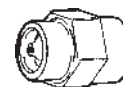

GREASE FITTING ADAPTER
 ADAPTS EARLY STYLE FITTINGS TO
 MODERN GREASE GUNS
 X-353000 EACH 3.95

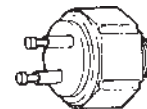

STOPTIGHT SWITCH
 1932 PASSENGER & COMMERCIAL
 B-13480-A EACH (NOS) 45.00

1933-34 TRUCK
 BB-13480-B EACH INQUIRE

1933-34 PASSENGER
 40-13480 EACH (NOS) 45.00

1935-58 PASSENGER
 48-13480 EACH (NOS) 45.00

1932-38 TRUCK
 81T-13480 EACH (NOS) INQUIRE

1939-48 ALL
 11A-13480 EACH 7.50

**USE OUR 800 NUMBER OR
 FAX NUMBER FOR
 PLACING YOUR ORDER!**

FRONT AXLE



FRONT AXLE BUMPERS

1932-34, PASSENGER & COMMERCIAL
B-3020 EACH 6.00

1935-38 FRONT, PASSENGER & COMM.
48-3020 PAIR 35.00

1939-40 FRONT, PASSENGER; 40-41 COMM.
91A-3020 PAIR 35.00

1941-42 FRONT, 1941-48 REAR
11A-3020 EACH 10.00

1942-47 PICKUP
21C-3020 EACH 10.00

1946-48 FRONT, PASSENGER
51A-3020 EACH 10.00

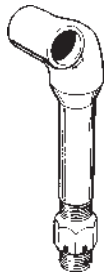

FRONT SPRING PERCH

1932-34, PASSENGER & COMMERCIAL
40-3030 EACH **N.O.S.** INQUIRE

1935-37, BIG TRUCK
51-3030 EACH **N.O.S.** INQUIRE

FRONT AXLE BOLTS

1935-36, PASSENGER & COMMERCIAL
48-3032 EACH **N.O.S.** INQUIRE

1937-39, PASSENGER, COMM., 41 COMM.
78-3032 EACH **N.O.S.** INQUIRE

1940-41, PASSENGER R.H.
01A-3032-C EACH INQUIRE

1940-41, PASSENGER L.H.
01A-3033-C EACH INQUIRE

1942-48, PASSENGER
21A-3040 EACH INQUIRE

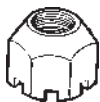

FRONT AXLE-BOLT NUT (SPRING PERCH NUT)

B-3036 EACH 1.50



STABILIZER BOOT

1940, PASSENGER (2 REQUIRED)
01A-3042 EACH INQUIRE



SPINDLE NUT

1928-35, PASSENGER & COMMERCIAL
B-1193 EACH 2.50

1936-48, PASSENGER & COMMERCIAL
68-1193 EACH 4.95

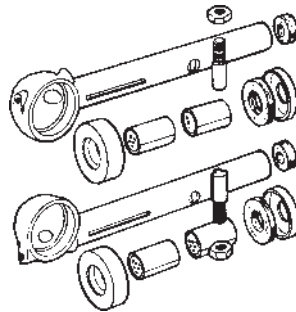

SPINDLE BOLT (KING PIN) & BUSHING KIT

1932-34, PASSENGER & COMMERCIAL
B-3111 KIT 135.00

1932-34, 1 TON BIG TRUCK
BB-3111 ORIGINAL SET 125.00

1935-36, PASSENGER & COMMERCIAL
48-3111 KIT 135.00

1935-37, 1 TON BIG TRUCK
51-3111 ORIGINAL SET 89.95

1937-41, PASSENGER & COMMERCIAL
78-3111 KIT 50.00

1938-48, 2 TON TRUCK
81T-3111 ORIGINAL SET 65.00

1942-48, PASSENGER & COMMERCIAL
21A-3111 KIT 50.00

**NOTE: ON PRE-"39 FORDS EQUIPPED
WITH HYDRAULIC BRAKES, USE KIT
FOR THE YEAR OF YOUR SPINDLES.**

SPINDLE BOLT REPAIR KIT

(CONTAINS SAME PARTS AS THE
"SPINDLE BOLT & BUSHING KIT" MINUS
THE KING PINS.)
1932-41, PASSENGER & COMMERCIAL
A-3111-XK KIT 40.00

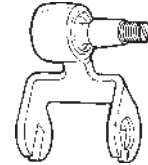

STABILIZER SWIVEL

1940-41, PASSENGER & COMM.
01A-3533/4 PAIR 63.00



STEERING ARM ADAPTER

USE WITH 39-48 SPINDLES ON 32-34 AXLE.
X-3131 EACH 35.00
OTHERS AVAILABLE - INQUIRE

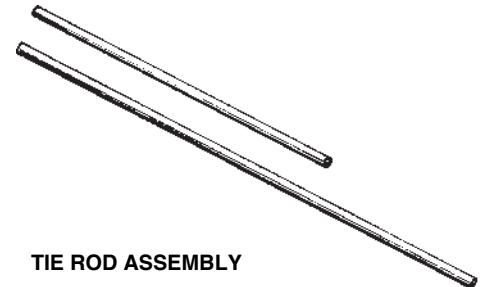

TIE ROD ASSEMBLY

1932-34, PASSENGER & COMMERCIAL
B-3281 EACH 27.50

1935-36, PASSENGER & COMM., 48"
48-3283 EACH 69.50

1937-41, PASSENGER & COMM., 43.65"
78-3283 EACH 69.50

1942-48, PASSENGER & COMM., 45.80"
21A-3283 EACH 69.50

TIE ROD ASSEMBLY - POLISHED STAINLESS STEEL AVAILABLE



SPINDLE ARM BALL-STUD

1938-48, 2 TON TRUCK
81W-3284 EACH 32.50

OTHERS AVAILABLE - INQUIRE

STEERING

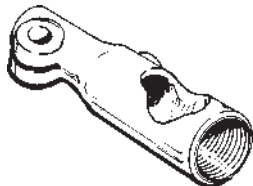

TIE ROD END HOUSING

1932-34, R.H.
B-3285 EACH 17.50

1932-34, L.H.
B-3286 EACH 17.50



TIE ROD END CLAMP

1935-48
48-3287 EACH 3.75



TIE ROD END

1935-48, PASSENGER & COMM., R.H.
11A-3270 EACH **USA** 24.50

1935-48, PASSENGER & COMM., L.H.
11A-3271 EACH **USA** 24.50

1935-48, 2 TON TRUCK, R.H.
7RT-3270 EACH 21.95

1935-48, 2 TON TRUCK, L.H.
7RT-3271 EACH 21.95



DRAG LINK

1932 PASSENGER & COMMERCIAL
B-3305 EACH 85.00

1933-34 PASSENGER & COMMERCIAL
40-3305 EACH INQUIRE

TRUCKS AVAILABLE - INQUIRE

NOS AVAILABLE



COMPLETE DRAG LINK

1935-41, PASSENGER & COMMERCIAL
11Y-3306 EACH 130.00

1941, CURVED AT ONE END
11A-3306 EACH 115.00

1942-48, PASSENGER
21A-3306 EACH 105.00

1942-47 COMMERCIAL
21C-3306 EACH **(NOS ONLY)** INQUIRE

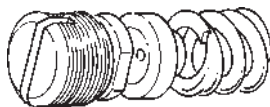

TIE ROD / DRAG LINK REPAIR KIT

1932-34, PASSENGER & COMMERCIAL
B-3305-RK EACH KIT (2 REQ'D) 15.00

TRUCK DRAG LINK REPAIR KIT

1940-48, 2 TON TRUCK (2 REQUIRED)
B5TZ-3A533-A KIT 29.75

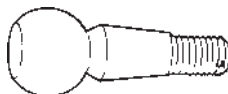

DRAG LINK & TIE ROD BALL-STUD

1932-34, PASSENGER & COMMERCIAL
THREADED
B-3311 EACH 10.00

1932-34, PASSENGER & COMMERCIAL
WELD-ON
B-3311-W EACH 5.50

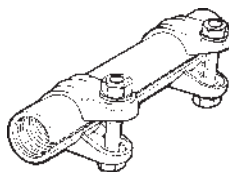

ADJUSTABLE DRAG LINK SLEEVE

1935-48, PASSENGER & COMMERCIAL
11A-3310 14.00



DRAG LINK & TIE ROD RUBBER SEAL

1932-34, PASSENGER & COMMERCIAL
BB-3332 SET OF 4 10.00



1935-48, PASSENGER & COMMERCIAL
48-3332-S SET OF 4 10.00



METAL CAP FOR BB-3332

1932-34, PASSENGER & COMMERCIAL
BB-3333 EACH 5.00

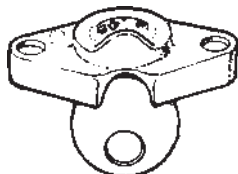

RADIUS ROD BALL CAP

1932-40, PASSENGER, 32-41 COMM.
B-3440 EACH 35.00

RADIUS ROD RUBBER BALL

1932-40 PASSENGER, 32-41 COMM.
B-3446 EACH 10.00

1941-48 PASSENGER
11A-3446 EACH 10.00

STEERING GEAR PARTS

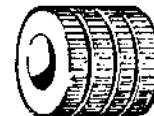

STEERING SHAFT UPPER BUSHING

1932-41 PASSENGER & COMMERCIAL
B-3517 EACH 5.00

RUBBER BUSHING WITH METAL SLEEVE
B-3517-N EACH 20.00

1932-39 TRUCK
BB-3517 EACH 4.00

1942-48 PASSENGER
51A-3517 EACH 5.00

RUBBER BUSHING WITH METAL SLEEVE
51A-3517-N EACH 19.50

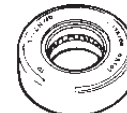

STEERING COLUMN UPPER BUSHING SLEEVE REPLACEMENT SET

BEARING, RACE & SPRING
1932-48, PASSENGER; 42-47 COMM.
21A-3517/18 KIT INQUIRE

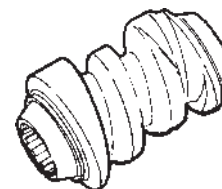

STEERING WORM GEAR

1932-34, PASS & COMM., 13:1 RATIO
B-3524 EACH 77.00

1932-34, PASS & COMM., 15:1 RATIO
40-3524 EACH 77.00

1935, PASS & COMM., 15:1 RATIO
48-3524 EACH 75.00

1936, PASS & COMM., 17:1 RATIO
68-3524 EACH 78.75

1937-48, PASS. & COMM.,
78-3524 EACH 75.00

STEERING (CONT'D)

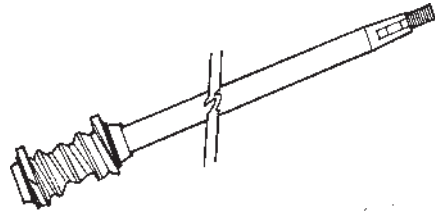

STEERING WORM GEAR & SHAFT ASSEMBLY

1938-39, 2 TON TRUCK 81T-3524 EACH	250.00
1939-40, MERCURY 09A-3524 EACH	250.00
1940-47, 2 TON TRUCK 01T-3524 EACH	250.00
1941-48, PASSENGER 11A-3524 EACH	250.00

OTHER N.O.S. - INQUIRE



STEERING WORM BEARING LOWER CUP

1932-36, PASSENGER & COMMERCIAL B-3552 EACH	10.50
1932-47, 2 TON TRUCK BB-3552 EACH	18.50
1937-48, PASSENGER & COMMERCIAL 8A-3553 EACH	32.50
1938-47, 2 TON TRUCK 81T-3553 EACH	34.50



STEERING WORM BEARING UPPER CUP

1932-36, PASSENGER & COMMERCIAL 68-3553 EACH	175.00
1937-48, PASSENGER & COMMERCIAL B-3552 EACH	10.50
1932-37, 2 TON TRUCK BB-3553 EACH	19.95



STEERING HOUSING END PLATE 1932-36, PASSENGER, 32-36 TRUCK B-3568-S SET	75.00
--	-------

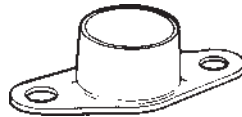

LIGHT SWITCH BRACKET 1932-36, PASSENGER, COMM., 32-37 TRUCK B-3569 EACH	6.95
--	------

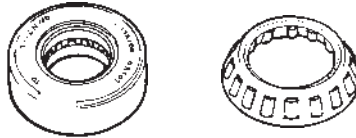

STEERING WORM BEARING 1932-35, PASSENGER & COMMERCIAL B-3571 EACH	11.50
1936-48, PASSENGER & COMMERCIAL 2 REQUIRED 1932-36 68-3571 EACH	12.00
1932-37, 2 TON TRUCK BB-3571 EACH	9.50
1938-47, 2 TON TRUCK 81T-3571 EACH	9.50

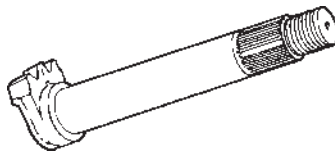

STEERING SECTOR 1932-34, PASSENGER & COMMERCIAL 13:1 RATIO B-3575 EACH	120.00
1932-34, PASSENGER & COMMERCIAL 15:1 RATIO 40-3575 EACH	120.00
1932-34, 1 TON TRUCK BB-3575 EACH	105.00
1935, PASSENGER & COMMERCIAL 15:1 RATIO 48-3575 EACH	95.00
1936, PASSENGER & COMMERCIAL 17:1 RATIO 68-3575 EACH	145.00
1935-37, 2 TON TRUCK 51-3575 EACH	140.00
1937-48, PASSENGER & COMMERCIAL 78-3575 EACH	INQUIRE
1938-39, 2 TON TRUCK 81T-3575 EACH	195.00
1940-47, 2 TON TRUCK 01T-3575 EACH	155.00

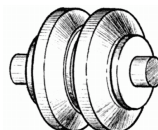

REPLACEMENT STEERING SECTOR & ROLLER 7RC-3575-X EACH	85.00
--	-------



STEERING SECTOR SHAFT BUSHING 1932-48, EX 36 PASSENGER & COMMERCIAL 78-3576 EACH	5.00
---	------

1932-37, 2 TON TRUCK BB-3576 EACH	5.00
--------------------------------------	------

1938-47, 2 TON TRUCK 81T-3576-A EACH	5.00
---	------

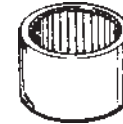

STEERING WORM SECTOR NEEDLE BEARING 1936, PASSENGER & COMMERCIAL 68-3576 EACH (2 REQ.)	15.00
---	-------

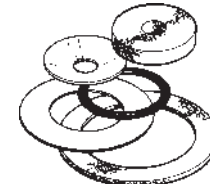

STEERING GEAR GASKET SET 1932-36, PASSENGER & COMMERCIAL B-3581-S SET	8.50
1937-48, PASSENGER & COMMERCIAL 78-3581-S SET	6.00

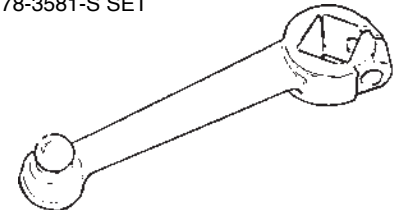

STEERING PITMAN ARM 1932-34, 2 TON TRUCK BB-3590 EACH	75.00
1933-34, PASSENGER 40-3590 EACH	75.00
1935-36, PASSENGER, COMM., 42-47 COMM 48-3590 EACH	75.00
1935-37, 2 TON TRUCK 51-3590 EACH	55.00
1937-41 PASSENGER 78-3590 EACH	75.00
1938-39, 2 TON TRUCK 81T-3590 EACH	55.00
1940-47, 2 TON TRUCK 01T-3590 EACH	55.00
1941, PASSENGER (USED WITH CURVED END DRAG LINK) 11A-3590-C EACH	38.95
1942-48, PASSENGER 21A-3590 EACH	75.00



STEERING GEAR OIL SEAL

1935-48, PASSENGER & COMMERCIAL
48-3591 EACH 5.95

1938-47, 2 TON TRUCK
81T-3591 EACH 5.95

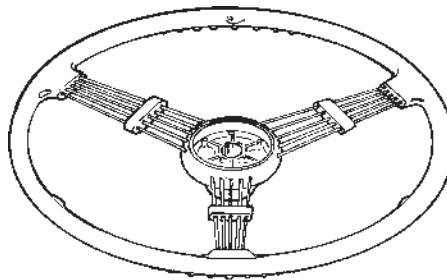

"BANJO" STEERING WHEEL

1935-36. PASSENGER
SUPER QUALITY! STAINLESS STEEL
SPOKES & SPACERS.
68-3600 EACH INQUIRE

1939 DELUXE "BANJO"
91A-3600-B EACH 235.00

STEERING WHEELS

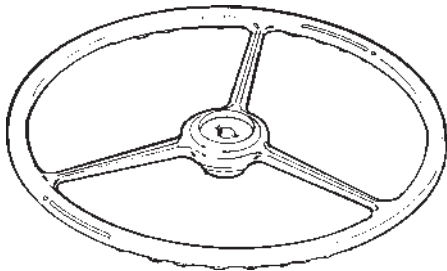

STEERING WHEEL

1932, PASSENGER & COMMERCIAL
EXACT DUPLICATE OF ORIGINAL
USING SAME MOULDED MATERIAL.
18-3600 EACH INQUIRE

1933-34, PASSENGER & COMMERCIAL
U.S.A. REPRODUCTION DUPLICATED
FROM A NEW ORIGINAL.
40-3600 EACH INQUIRE

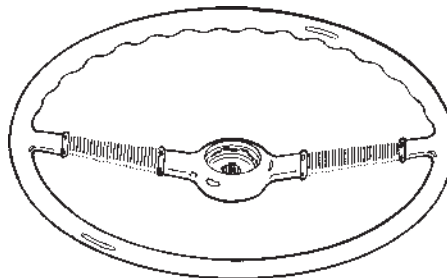

STEERING WHEEL

1940, STANDARD & 40-41 PICKUP
01A-3600-STD EACH INQUIRE

1940, DELUXE
01A-3600-DLX EACH 300.00
FOR GM STEERING COLUMN
01A-3600-SR EACH 315.00

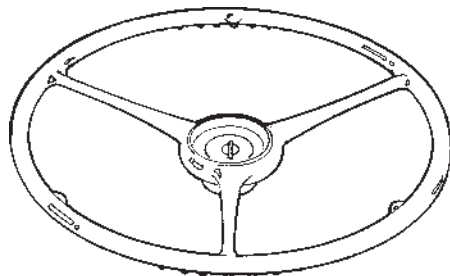

STEERING WHEEL

1935-36, PASSENGER & COMMERCIAL
68-3600-A EACH 210.00

1937-39 STD. & 37-39 PICKUP
78-3600-A EACH 210.00

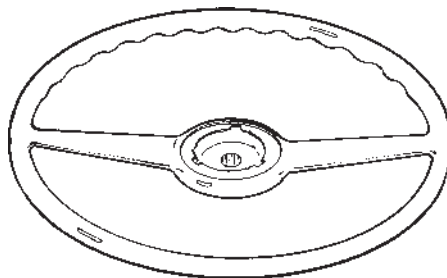

STEERING WHEEL

1941-48, PASSENGER
6A-3600 EACH 175.00



STEERING WHEEL ADAPTOR
B-3600-ADP EACH \$35.00
CONVERT YOUR KEYED STEERING
COLUMN TO FIT A 3-BOLT WHEEL



HORN BUTTON SPRING

1940-41, PASSENGER, 40-47 COMM.
01A-3626 EACH 3.00

1942-48, PASSENGER
21A-3626 EACH 3.00

STEERING WHEEL PAINT

1940 DELUXE MAROON (12 3/4 OZ.)
01A-3601-S EACH INQUIRE

1940 DELUXE TAN (12 3/4 OZ.)
01A-3602-S EACH INQUIRE

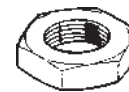

STEERING WHEEL NUT

1932-41, PASSENGER & COMMERCIAL
B-3610 EACH .75



STEERING WHEEL KEY

1932-48, PASSENGER & COMMERCIAL
B-3609 EACH 2.00

SOME OF THESE ARE LOW
PRODUCTION AND AVAIL-
ABLE SPORADICALLY
PLEASE INQUIRE

STEERING COLUMN

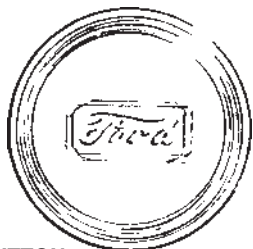

HORN BUTTON

1940, STANDARD, BROWN
01A-3627-A EACH 21.00

1940, DELUXE, MAHOGANY
01A-3627-B EACH 21.00

1940-47, COMMERCIAL, BLACK
11C-3627-A EACH 21.00

FIX FIX FIX FIX FIX FIX

1942-48 PASSENGER (BLUE HIGHLIGHTS)
6A-3627-B EACH 30.00
1942-48 PASSENGER (GOLD HIGHLIGHTS)
6A-3627 EACH 30.00

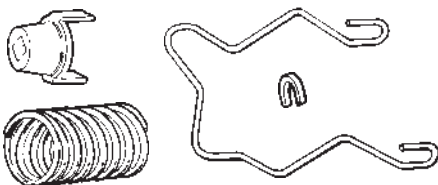

LIGHT SWITCH SPIDER SPRING

1932-39
B-3642 EACH 1.25

LIGHT SWITCH SPIDER

1932-39
B-3643 EACH 3.50

LIGHT SWITCH SPIDER RETAINER

1932-39
B-3644 EACH .50

LIGHT SWITCH BAIL

1928-36
B-3647-A EACH 3.00
1937-39
78-3647 EACH 10.00

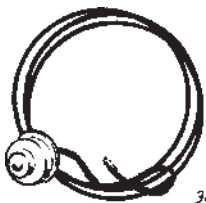

HORN BUTTON WIRE

1940, PASSENGER; 40-47 PICKUP
01A-3671 EACH 15.00

**SEE PAGE 68 FOR MORE HORN
BUTTON WIRES.**



HORN BUTTON INSULATOR

1941-48, PASSENGER
11A-3672 EACH 6.00

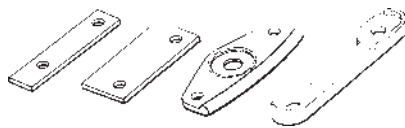

IGNITION LOCK STEERING SHIM

1932, PASSENGER & COMMERCIAL
B-3682 EACH 2.50

1933-34, PASSENGER & COMMERCIAL
40-3682 EACH 2.50

1935-37, PASSENGER & COMMERCIAL
48-3682 EACH 3.00

1938-39, PASSENGER & COMMERCIAL
81A-3682 EACH 5.50

1940, PASSENGER
01A-3682 PAIR 2.50

1941-48 PASSENGER
11A-3682 EACH 5.50

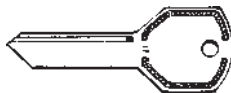

ORIGINAL "HURD" KEY BLANKS

1932-34, DOOR LOCK
B-3685-KA EACH INQUIRE

1932-48, IGNITION; 35-48, DOOR LOCK
B-3685-KB EACH INQUIRE

1932-48, DECK HANDLE; 32-48 SPARE
TIRE LOCK; 35-48 GLOVE BOX LOCK
B-3685-KC EACH INQUIRE

REPRODUCTION KEY BLANKS PAGE 162

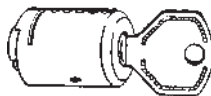

IGNITION LOCK CYLINDER W/KEYS

1932-35 PASSENGER (ORIGINAL)
B-3686 EACH 150.00
1936-47 PASSENGER (ORIGINAL)
91A-3686 EACH 125.00
1936-47 (REPLACEMENT)
48-3686 EACH 18.00

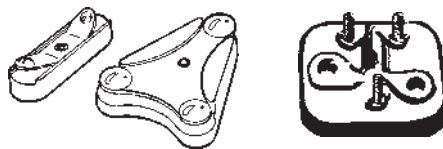

IGNITION SWITCH LOCK BODY & BRUSH

1932-37 ALL BODY ONLY
B-3704 EACH 18.00

1932-37 ALL BRUSH ONLY
B-3709 EACH 40.00

1938-40, PASSENGER; 38-47 PICKUP
BODY & BRUSH KIT
81A-3704/9-K 25.00

1941-48, PASSENGER
11A-3680 EACH 75.00



IGNITION SWITCH HOUSING CASE

1932-37 PASSENGER
B-3712 EACH 25.00

1938-40 PASSENGER, COMM & TK
81A-3712 25.00



IGNITION LOCK RETAINING PIN

1932-35, ALL
B-3729 EACH 3.00

1936-48 PASSENGER; 36-47 COMM. &
TRUCK
68-3729 EACH 3.50



STEERING COLUMN LOCK BOLT

1932-48, ALL
B-3731 EACH 5.00

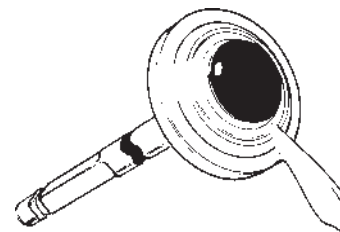

LIGHT SWITCH AND HORN ROD

1932 PASSENGER & PICKUP
B-3616 EACH 55.00

1933-34 PASSENGER & PICKUP
40-3616 EACH ORIGINAL ONLY INQUIRE

1935-36 PASSENGER & PICKUP
BROWN
48-3616-A EACH ORIGINAL ONLY INQUIRE

1935-36 PASSENGER & PICKUP
BLACK
48-3616-B EACH ORIGINAL ONLY INQUIRE

1937-39
78-3616 EACH ORIGINAL ONLY INQUIRE

1932-34 TRUCK
BB-3616 EACH 55.00

1935-37 TRUCK
51-3616 EACH 70.00

DIFFERENTIAL

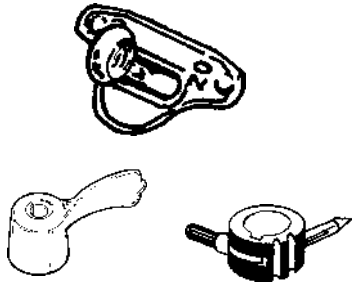

IGNITION SWITCH LEVER

1932 PASSENGER, '32-35 TRUCK
B-3735 EACH INQUIRE

1933-34 PASSENGER
40-3735 EACH 25.00

1940 ALL
SWITCH LEVER, PLATE & BUTTON
01A-3676-K 45.00

1941-48 PASSENGER
11A-3714 EACH INQUIRE



REAR HUB PULLER

1928-48 ALL
A-1114-T EACH 200.00

THIS TOOL IS AVAILABLE FOR RENT
\$10.00 PER DAY
WITH \$200.00 DEPOSIT



DIFFERENTIAL DRAIN PLUG
1932-48 PASSENGER; 32-47 COMM.
18-4030 EACH 1.25

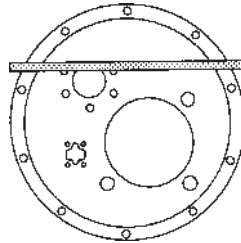

REAR AXLE GASKET SETS

SUPER SETS HAVE ALL THE GASKETS
NEEDED FOR THE DIFFERENTIAL,
INCLUDING REAR AXLE HOUSING GAS-
KETS OF VARIOUS THICKNESSES FOR
PROPER RING & PINION BACKLASH
ADJUSTMENT.

1932 V8 & 4 CYLINDER
B-4035-SS SUPER SET 25.00

1932 (LATE)-48, V8
18-4035-SS SUPER SET 25.00

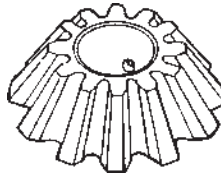

SPIDER GEARS ORINGAL ONLY

1928-32 PASSENGER & COMMERCIAL
12 TEETH
B-4215 EACH 50.00

1932-38 PASSENGER & COMMERCIAL
12 TEETH
18-4215 EACH 50.00

1939-48 PASSENGER, 39-47 COMM.
11 TEETH
81A-4215 EACH 50.00



REAR AXLE HOUSING SLEEVE

PROVIDES A NEW CASE HARDENED
BEARING SURFACE FOR REAR WHEEL
BEARING. INSTRUCTIONS INCLUDED.

1932-48 PASSENGER; 40-47 COMM.
B-4012 EACH 64.75

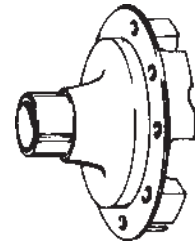

SPIDER-GEAR CASE N.O.S. OR USED AVAILABLE

1932-48 PASSENGER; 32-47 COMM.
R.H. (SMALL)
18-4205 EACH INQUIRE

1932-48 PASSENGER; 32-47 COMM.
L.H. (LARGE)
18-4206 EACH INQUIRE

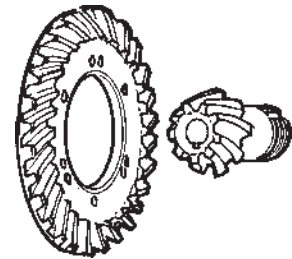

QUALITY U.S.A. RING & PINION GEAR SET

1933-34 PASSENGER & COMMERCIAL
3.54 RATIO
40-4209-B SET 650.00

1935-48 PASSENGER & COMMERCIAL
4.11 RATIO
48-4209-D SET INQUIRE

1935-48 PASSENGER; 35-41 COMM.
3.78 RATIO
68-4209-A SET 650.00

1935-48 PASSENGER; 35-41 COMM.
3.54 RATIO
68-4209-HS SET 550.00

1935-39 2 TON TRUCK
6.66:1 WITH SPLINED PINION
79-4209-A SET INQUIRE

1940-48 2 TON TRUCK
6.66:1 WITH KEYED PINION
01T-4209-A SET INQUIRE

1940-52 122" TRUCK
4.857:1 RATIO
01Y-4209-B SET INQUIRE

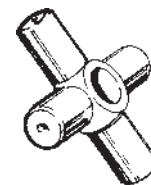

DIFFERENTIAL 4-PRONG SPIDER

1932-48 PASSENGER; 32-47 COMM.
18-4211 EACH 49.95

**USE OUR 800 NUMBER OR
FAX NUMBER FOR
PLACING YOUR ORDER!**

DIFFERENTIAL

(CONT'D.)

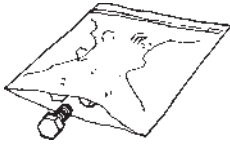

REAR AXLE HOUSING TO BANJO BOLT

1932-48 PASSENGER; 32-47 COMM.
B-4212 SET OF 20 8.95

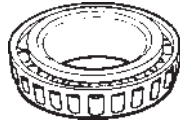

DIFFERENTIAL BEARING

1932-36 PASSENGER & COMMERCIAL
18-4221 EACH 55.75

1937-48 PASSENGER; 37-47 COMM.
68-4221 EACH 46.50

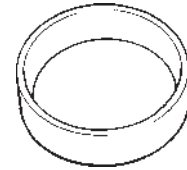

DIFFERENTIAL BEARING CUP

1932-36 PASSENGER & COMMERCIAL
18-4222 EACH 24.50

1937-48 PASSENGER; 37-48 COMM.
68-4222 EACH 21.75

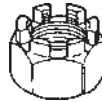

REAR AXLE NUT

1909-1948
B-4242 EACH 2.00



REAR AXLE - N.O.S.

1932-34 PASSENGER & COMMERCIAL
18-4235 EACH INQUIRE

1935-41 PASSENGER & COMMERCIAL
32.85" 18 TEETH
48-4235 EACH 350.00

1938-41 PASSENGER & COMMERCIAL
32.85" 16 TEETH
81A-4235 EACH 350.00

1942-48 PASSENGER & COMMERCIAL
33.70" 16 TEETH
21A-4235 EACH 350.00

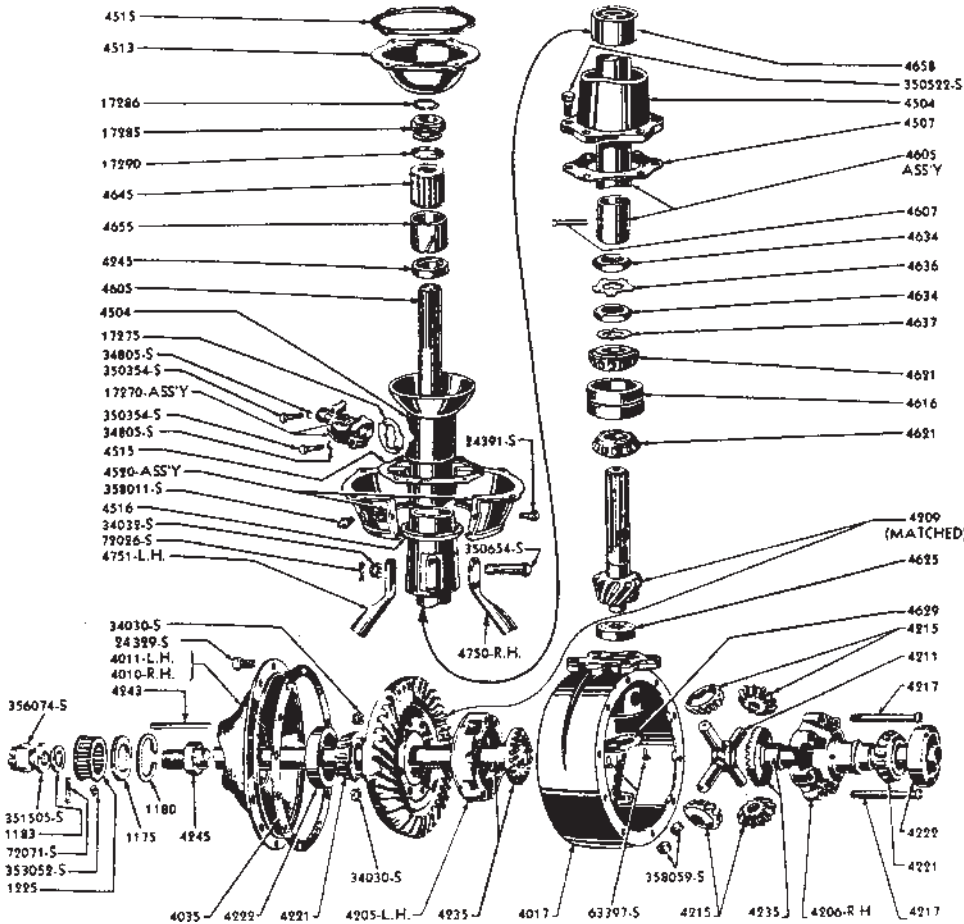

USED ALSO AVAILABLE - INQUIRE



REAR AXLE SHIM
1932-48 PASSENGER; 32-47 COMM.
AS-4235 EACH 1.25

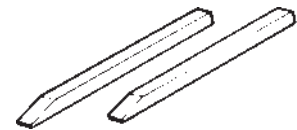

REAR AXLE KEY
1932-48 PASSENGER; 32-47 COMM.
B-4243 EACH 1.95



REAR AXLE & DRIVESHAFT SEAL
1932-48 PASSENGER; 32-47 COMM.
B-4245 EACH (3 REQ'D) 3.95

1933-48 COLUMBIA REPAIR KIT

DIE STAMPED FROM SOLID BRASS, THESE WASHERS REPLACE WORN WASHERS WHICH CAN DESTROY YOUR COLUMBIA.
48-4059/60-S KIT 30.00

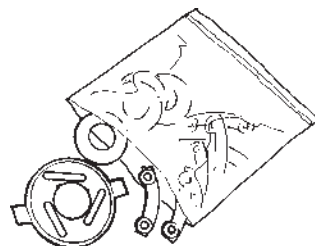

INNER AXLE SEAL
1932-34 TRUCK
BB-4245-A EACH 14.95

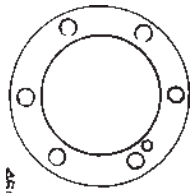

TORQUE TUBE REAR GASKET

1932-34 PASSENGER & COMMERCIAL
18-4507 EACH. 2.00

1935-48 PASSENGER; 35-47 COMM.
48-4507 EACH 2.50

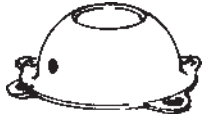

U-JOINT INNER CAP

1932-48 PASSENGER; 32-41 COMM.
B-4513 EACH INQUIRE

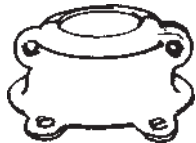

U-JOINT OUTER CAP

1932-48 PASSENGER; 32-41 COMM.
48-4520 EACH INQUIRE

DRIVE SHAFT

1932-48 PASS, COMM & TRUCK
68-4605 EACH INQUIRE

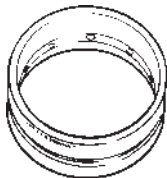
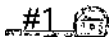

PINION BEARING CUP

1932-34 PASSENGER & COMMERCIAL
18-4616 EACH 95.00

1935-48 PASSENGER; 35-47 COMM.
48-4616 EACH 68.00

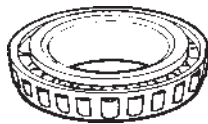

PINION FRONT BEARING

1932-34 PASSENGER & COMMERCIAL
18-4621 EACH 21.95

1935-48 PASSENGER; 35-47 COMM.
48-4621 EACH 44.50

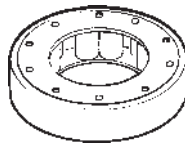

PINION REAR BEARING

1932-48 PASSENGER; 32-47 COMM.
18-4625-A EACH 37.75



PINION BEARING NUT

1932-48 PASSENGER; 32-47 COMM.
18-4634 EACH 6.95



LOCK NUT WASHER

01Y-4636 EACH 2.50

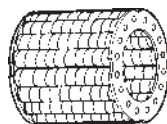

DRIVE SHAFT ROLLER BEARING

1932-48 PASSENGER; 32-41 COMM.
B-4645 EACH 16.00

1932-39, 1 & 2 TON TRUCKS
BB-4645 EACH 17.50



DRIVE SHAFT LOCK PIN

2.04" LENGTH - 10 SPLINE PINION
48-4607 EACH 1.50

1.70" LENGTH - 6 SPLINE PINION
68-4607 EACH 1.50

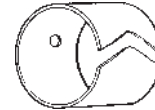

DRIVESHAFT ROLLER BEARING SLEEVE

1932-48 PASSENGER; 32-41 COMM.
B-4655 EACH 8.95

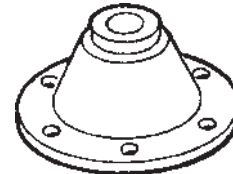

PINION RETAINER CAP

1940-48 COMMERCIAL
01Y-4674 EACH INQUIRE



PINION SEAL

1940-48 3/4 & 1 TON
01Y-4676 EACH INQUIRE

1940-48 2 TON TRUCK
01T-4676 EACH 11.95



DRIVE SHAFT COUPLING (6 SPINES)

1937-48 PASSENGER & COMMERCIAL
68-4684 EACH 54.95

6 SPLINE TO 10 SPLINE ADAPTER SLEEVE

1937-48 PASSENGER & COMMERCIAL
48-4684 EACH 99.50

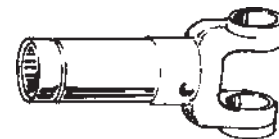

DRIVE SHAFT "SLIP YOKE"

1942-48 COMMERCIAL
21C-4841 EACH 125.00

1940-48 3/4 & 1 TON
01Y-4841 EACH INQUIRE

1940-48 2 TON TRUCK
01T-4841 EACH 75.00

MORE DIFFERENTIAL AND REAR AXLE PARTS AVAILABLE - PLEASE INQUIRE



HAND BRAKE OPERATING LEVER
GOOD USED ORIGINALS

1939-1948 PASSENGER & COMMERCIAL
91A-2103 (RIGHT) EACH 25.00
91A-2104 (LEFT) EACH 25.00

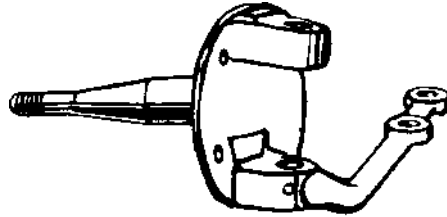

SPINDLES
GOOD USED ORIGINALS

1932-34 PASSENGER & COMMERCIAL
B-3105/6 PAIR 200.00

1935-36 PASSENGER & COMMERCIAL
48-3105/6 PAIR 200.00

1937-41 PASSENGER & COMMERCIAL
78-3105/6 PAIR 200.00

1942-48 PASSENGER & COMMERCIAL
21A-3105/6 PAIR 200.00

N.O.S. & TRUCK SPINDLES AVAILABLE



HAND BRAKE OPERATING LEVER LINK
GOOD USED ORIGINALS

1939-1948 PASSENGER & COMMERCIAL
91A-2108 (RIGHT) EACH 25.00
91A-2109 (LEFT) EACH 25.00

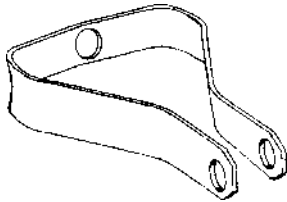

REAR BRAKE HOSE BRACKET

1941-48 PASSENGER
99A-2073 EACH 7.50

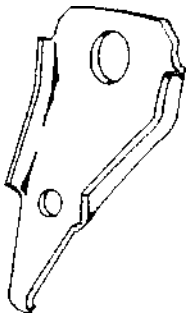

FRONT BRAKE HOSE BRACKET

1939-48 PASSENGER & COMMERCIAL
91A-2082 EACH (TWO REQUIRED) 22.50

CALL: 1-800-532-1932

COMING SOON !!!- TRY OUR
WEBSITE AT: allfordparts.com
E-mail: allford@jps.net



ALL FORD PARTS

1600 DELL AVENUE, SUITE A, CAMPBELL, CALIFORNIA 95008

408-378-1935 • 1-800-532-1932 • FAX: 408-866-1934