

# 2011 UPDATED CATALOG

CALL: 1-800-532-1932

COMING SOON !!!- TRY OUR  
WEBSITE AT: [allfordparts.com](http://allfordparts.com)  
E-mail: [allford@jps.net](mailto:allford@jps.net)

1909



1948

**POLICIES**

**TOLL FREE ORDER NUMBER: 1-800-532-1932**

- RETURNS** All items returned must be accompanied with a copy of the invoice. No returns on electrical items. Returns will not be accepted if the item has been altered, painted, primered or modified. No returns on special order or custom items. Returns after 30 days are subject to a 20% RESTOCKING FEE. No returns will be accepted after 6 months. Returns must be shipped pre-paid at owners expense. NO C.O.D.'s are accepted.
- CORES** Rebuilt or refurbished items will require a core or be charged a core charge prior to shipping. Core charges will be refunded when a rebuildable core is returned with a copy of the invoice. The core returned must be able to be rebuilt in order to receive a full refund. Cores that are damaged or rusted beyond repair will not be given a refund. All core returns must be shipped pre-paid at owners expense. No C.O.D.'s are accepted.
- DAMAGES - SHORTAGES** All claims for damages or shortages must be made within 48 hours of receiving your package. Claims on freight shipments must be made at time of receipt to the courier of the freight company before he leaves your business/residence. Please keep all packaing & cartons until claim has been completed. Please make driver note in system any visable damage of packaging to the driver at time of delivery.
- FOREIGN ORDERS** Payable in U.S. FUNDS only; by money order, bank check, or VISA/ DISCOVER/MASTERCARD (BEST & FASTEST). Please add 25% for shipping. There will be no backorders on foreign orders - please reorder.
- PRICE CHANGES** Due to unforeseen price increases from our suppliers, prices are subject to change without notice. Additional charges will be charged to your credit card or sent C.O.D.
- ORDERING** Phone, mail, fax or e-mail orders accepted. Please have all information available at time of order to help speed your order along. We accept VISA, MASTERCARD or DISCOVER, money orders and personal checks (may delay order). We also ship C.O.D. (Additional \$10 shipping). All items are shipped via Fed-Ex or USPS. Unless specified, all items that are temporarily out-of-stock will be backordered. Most backorders will be shipped within 1-3 weeks.
- SALES TAX** CALIFORNIA residents: Include sales tax rate of 7.5% for orders shipped. 8.5% over the counter.
- SHIPPING** Orders are primarily shipped by Fed-Ex or USPS. Items exceeding Fed-Ex weight or size limit will be shipped by truck freight or by Greyhound bus. (\$15 additional charge for orders shipped greyhound or freight requiring delivery to a depot or airport). Add \$10 for C.O.D. orders. Please specify if you would like a particular shipping method or delivery date/time. Shipping company is decided based on price, time-in-transit, & convience. Fed-Ex has a number of additional charges such as residential delivery, Rural delivery, and unusual & oversize pacakge. This will affect the final total of your shipping amount.

NEXT-DAY AIR, 2ND DAY AIR, 3RD DAY AVAILABLE AT ADDITIONAL COST

**Shipping Price Estimates:**

	<b>Mail</b>	<b>Priority Mail</b>			<b>FedEx</b>		
	Small under 1 lb	Flat Rate			Ground		
		Small	Medium	Large	Business	Resident	Rural-Residnt
<b>Minimum:</b>	\$2.75	\$6.00	\$11.50	\$15.20	\$6.64	\$9.83	\$12.73
<b>Average:</b>	\$3.50	\$6.00	\$11.50	\$15.20	\$9.60	\$12.02	\$15.55
	Small items only, no tracking	Parts must fit in flat rate size box. Insurance for \$50-\$250 add \$1. 2-3 est. delivery time.			Rural is for businesses/homes not in or near a major city. Average prices are estimates only. Large/Irregular shape items add \$8 and up.		

<b>Insurance Rates:</b>	\$100-\$500	\$1.00	\$500+	\$2.50 & up
-------------------------	-------------	--------	--------	-------------

**International:** International shipments primarily ship out USPS Priority Mail, we try to get you the cheapest rate possible. Please call or email you order and we can give you a rate quote for shipping.

\*Average is an estimate of our average order with no dimension exceeding 24" and under \$500.00. Larger orders are harder to estimate shipping amount. Running boards, bumpers, fenders, and other large items please call for shipping quotes.



# INDEX

FOR THIS CATALOG WE HAVE, FOR THE MOST PART, USED FORD'S ORIGINAL NUMBERING SYSTEM. BELOW WE HAVE LISTED THE GROUP, GROUP NUMBERS AND THE PAGES EACH GROUP OCCUPIES IN OUR CATALOG. A MORE SPECIFIC INDEX IS INCLUDED ON THE FOLLOWING PAGES FOR YOUR CONVENIENCE. IF YOU CAN'T FIND WHAT YOU NEED PLEASE INQUIRE!

<b>WHEELS, HUBS &amp; TIRES</b> 1000-1723 ..... 6 to 10	<b>RADIATOR</b> 8000-8499 ..... 43 to 51	<b>LAMPS</b> 13002-13799 ..... 74 to 83
<b>BRAKES</b> 2004-2666 ..... 11 to 15	<b>WATER PUMP</b> 8500-8599 ..... 49	<b>HORN</b> 13800-13899 ..... 85 & 86
<b>FRONT AXLE</b> 3010-3446 ..... 16 & 17	<b>FAN</b> 8600-8693 ..... 49 to 52	<b>WIRING</b> 14054-14621 ..... 66 TO 69, 87 & 88
<b>STEERING GEAR</b> 3503-3743 ..... 18 to 20	<b>FUEL TANK</b> 9001-9326 ..... 53 to 55	<b>ACCESSORIES</b> 15001-15709 ..... 89 to 91
<b>REAR AXLE</b> 4000-4906 ..... 21 to 23	<b>FUEL PUMP</b> 9270-9420 ..... 55 & 56	<b>FENDERS</b> 16000-16449 ..... 92 to 94
<b>FRAME &amp; BRACKETS</b> 5000-5149 ..... 25 & 26	<b>MANIFOLDS, CLAMPS, ETC.</b> 9421-9499 ..... 56	<b>RUNNING BOARD</b> 16450-16599 ..... 95 to 97
<b>BATTERY BRACKETS &amp; PARTS</b> 5150-5199 ..... 26 & 27	<b>CARBUREATOR</b> 9502-9685 ..... 56 & 57	<b>HOOD</b> 16600-16799 ..... 98 to 107
<b>MUFFLER &amp; EXHAUST PIPE</b> 5230-5293 ..... 27 & 28	<b>THROTTLE CONTROL</b> 9700-9828 ..... 56 to 61	<b>SPEEDOMETER</b> 17250-17499 ..... 109 & 110
<b>SPRINGS</b> 5300-5818 ..... 28 & 29	<b>GENERATOR &amp; BATTERY</b> 10000-10848 ..... 63-64	<b>WINDSHIELD WIPER</b> 17500-17674 ..... 110 to 113
<b>ENGINE</b> 6000-6928 ..... 31 to 36	<b>INSTRUMENTS</b> 10849-10899 ..... 54, 55, 64 & 109	<b>MIRRORS</b> 17679-17745 ..... 114 to 117
<b>TRANSMISSION</b> 7000-7449 ..... 37 to 40	<b>STARTER MOTOR</b> 11000-11516 ..... 65	<b>BUMPERS</b> 17750-17999 ..... 118 to 120
<b>CLUTCH</b> 7500-7646 ..... 40 & 41	<b>LIGHT SWITCH</b> 11648-11688 ..... 66	<b>SHOCK ABSORBER</b> 18000-18199 ..... 121
	<b>IGNITION</b> 12000-12425 ..... 70 to 72	<b>ACCESSORIES</b> 18400-18600 ..... 121 to 128
<hr/>		
<b>FASTENERS</b> ..... 129 to 135	<b>GLOVE BOX</b> ..... 154	<b>TRANSMISSION COVERS</b> ..... 178
<b>FLOOR SEALS</b> ..... 137, 138 & 172	<b>WINDOW CHANNEL</b> ..... 155 to 158	<b>FLOOR MATS</b> ..... 179
<b>COWL VENT</b> ..... 138	<b>DOOR SCUFF PLATES</b> ..... 159	<b>FIREWALL INSULATION</b> ..... 181
<b>BODY PATCH PANELS</b> ..... 139 & 140	<b>SUN VISORS</b> ..... 160	<b>WINDOW SEALS</b> ..... 152, 153 & 182 to 184
<b>DOOR HARDWARE</b> ..... 140 & 141	<b>WINDOW REGULATORS</b> ..... 161	<b>TRUNK</b> ..... 185 & 186
<b>WINDSHIELD FRAMES</b> ..... 142 to 144	<b>DOOR PULLS &amp; LOCKS</b> ..... 141, 162	<b>HANDLES &amp; CRANKS</b> ..... 83, 84, 187 to 193
<b>SHEET METAL</b> ..... 145 to 148, 227 to 228	<b>DOOR SEALS</b> ..... 163 & 164	<b>ESCUTCHEONS</b> ..... 191
<b>RUMBLE SEAT</b> ..... 149 & 150	<b>SEAT SPRINGS</b> ..... 165 to 168	<b>FIBERGLASS</b> ..... 194 to 204
<b>TOP IRONS</b> ..... 151	<b>STRIKER PLATES</b> ..... 140, 150 & 169	<b>DECALS</b> ..... 136
<b>CONVERTIBLE</b> ..... 152 to 154	<b>WOOD</b> ..... 170 to 172	<b>BOOKS</b> ..... 219 to 226
	<b>PICKUP</b> ..... 173 TO 177, 180	<b>STREET ROD</b> ..... 205 to 264

# INDEX

## A

A-ARMS ..... 247-249  
 ACCELERATOR PEDAL ..... 57  
 ACCESSORIES (STREET ROD) ..... 89-91, 121-124, 262,263  
 ADAPTERS (ENGINE TO TRANSMISSION) ..... 42  
 AIR CLEANER ..... 56, 211  
 ANTENNAS ..... 126  
 ANTI-SQUEAK PAD ..... 120  
 ANTI-ROLL BAR ..... 246,256  
 APRONS ..... 93  
 ARM RESTS ..... 169, 205  
 ASH TRAY KNOBS ..... 61  
 ASH TRAYS ..... 61  
 AXLE ASSEMBLIES (STREET ROD) ..... 245  
 AXLE BOLTS ..... 16  
 AXLE BUMPERS (FRONT) ..... 16  
 AXLE BUMPERS (REAR) ..... 29  
 AXLE - DROPPED ..... 245, 250

## B

BACK WINDOW FRAME ..... 151  
 BACK WINDOW RUBBER ..... 184  
 BACKUP LAMP SWITCH ..... 91  
 BATTERY ..... 64  
 BATTERY BOX ..... 26, 210, 262  
 BATTERY CABLES ..... 87  
 BATTERY CABLE BRACKETS ..... 87, 88  
 BATTERY DEFLECTOR ..... 26,178  
 BATTERY DISCONNECT SWITCH ..... 87  
 BATTERY HOLD DOWN FRAME ..... 26  
 BATTERY HOLD DOWN PAD ..... 26  
 BEAUTY RINGS ..... 7  
 BED FLOORING (WOOD) ..... 176  
 BED FLOORS ..... 174  
 BED STRIPS ..... 176  
 BELTS ..... 51  
 BELT BUCKLES & CAPS ..... 128  
 "BLACK BOX" ..... 207  
 BLUE DOT LENS ..... 81  
 BODIES STEEL (FIBERGLASS) ..... 146 (194)  
 BODY EMBLEMS ..... 94, 175, 178, 179, 213  
 BODY INSULATION ..... 181  
 BODY-TO-FRAME GUSSET ..... 178  
 BODY MOULDING CLIPS ..... 129  
 BODY MOULDINGS ..... 102, 107  
 BODY NUMBER PLATES ..... 124  
 BODY PANELS ..... 139, 140, 146-8  
 BODY PATCH PANELS ..... 139  
 BODY-TO-FRAME PADS ..... 25, 120  
 BODY SOCKETS ..... 134  
 BOLT KITS ..... 134, 135  
 BOOKS ..... 219 TO 226  
 BRAKE PARTS ..... 11 TO 15, 246-259  
 BRAKE COMPONENTS (STREET ROD) ..... 211, 246-259  
 BRAKE & CLUTCH PEDAL BUMPERS ..... 137  
 BRAKE & CLUTCH PEDAL PADS ..... 14, 262  
 BRAKE DRUMS ..... 8  
 BRAKE FLUID ..... 259  
 BRAKE HANDLE ..... 15, 259  
 BRAKE HOSE ..... 12, 259  
 BRAKE LINES ..... 13, 259  
 BRAKE LINING ..... 11  
 BRAKE PEDAL ASSEMBLIES ..... 211, 259  
 BRAKE RODS ..... 14  
 BRAS ..... 91  
 BUG SCREENS ..... 45  
 BUMPER PARTS ..... 119 TO 120  
 BUMPER BOLTS ..... 119  
 BUMPER BRACKETS ..... 118  
 BUMPER BRACKET GROMMETS ..... 120  
 BUMPER GUARDS ..... 119  
 BUMPER TIPS ..... 120  
 BUMPER-TO-BODY SEAL ..... 120  
 BUMPERS ..... 118  
 BUMPERS (DOOR) ..... 158

## C

CAMSHAFT ..... 33  
 CAMSHAFT BEARINGS ..... 34  
 CAPS ..... 124  
 CARBURETOR ..... 56, 57  
 CAR COVERS ..... 91  
 CHASSIS - STREET ROD ..... 234-243  
 CHOKE RODS ..... 56  
 CHOKE ROD & CABLE KITS ..... 62  
 CHASSIS AND FRAMES ..... 233-243  
 CHASSIS COMPONENTS ..... 246-262  
 CHASSIS (PRO-COMP) ..... 242, 243  
 CIGAR LIGHTERS ..... 90, 108  
 CIRCUIT BREAKER ..... 71  
 CLOCK ASSEMBLY ..... 89  
 CLEVICE ..... 264  
 CLOCK BEZEL ..... 60  
 CLOCK FACE ..... 89  
 CLOCK KNOB ..... 89  
 CLOCK LIGHT WIRE ..... 66, 89  
 CLOCK MIRRORS ..... 115

CLOCK PANELS ..... 60  
 CLUTCH PARTS ..... 40, 41  
 COLUMBIA REPAIR KIT ..... 22  
 COLUMBIA DECAL ..... 225  
 COLUMBIA KNOBS ..... 153  
 COLUMBIA INSTRUCTIONS ..... 225  
 COIL ..... 70  
 COIL-OVERS ..... 247, 248, 251, 255  
 CONDENSERS ..... 71  
 CONDENSER BOOT ..... 71  
 CONNECTING RODS ..... 33  
 CONVERTIBLE DOOR BUMPER KIT ..... 158  
 CONVERTIBLE HEADER BRACKET ..... 151  
 CONVERTIBLE RUBBER ..... 152, 153  
 CONVERTIBLE TOP IRONS ..... 151, 204  
 CONVERTIBLE TOP PARTS ..... 151 TO 154, 204  
 CONVERTIBLE WINDOW CHANNEL ..... 152  
 COMPRESSOR, AIR CONDITIONING ..... 207  
 COOLING SYSTEM ..... 43 TO 52  
 COOLING SYSTEM (STREET ROD) ..... 260  
 COWL-TO-FENDER SEAL ..... 93  
 COWL-TO-FIREWALL SEAL ..... 138  
 COWL LACING ..... 104  
 COWL LAMPS ..... 77, 78  
 COWL LAMP LENS ..... 78  
 COWL LAMP PADS ..... 78  
 COWL MIRRORS ..... 116  
 COWL MOULDINGS ..... 107  
 COWL PATCH PANELS ..... 139  
 COWL TRIM ..... 107  
 COWL VENT GASKET ..... 138  
 COWL VENT HANDLE ..... 138  
 COWL VENT HINGE ..... 138  
 COWL VENT KNOBS ..... 59  
 COWL VENT LID ..... 138, 201  
 COWL VENT PARTS ..... 138, 139, 201  
 COWL VENT RATCHET ..... 138  
 COWL VENT SCREEN ..... 138  
 CRANK HOLE COVER ..... 47  
 CRANKING TOOL ..... 109  
 CRANKSHAFT GEAR ..... 34  
 CROSSMEMBERS (STREET ROD) ..... 212, 246, 248, 255, 261  
 CROSSOVER PIPE ..... 27  
 CURTAIN ROD SOCKET ..... 134  
 CUT-OUT SWITCH ..... 63  
 CYLINDER HEAD ..... 31, 42  
 CYLINDER HEAD HARDWARE ..... 31, 32  
 CYLINDER SLEEVE ..... 31

## D

DASH GROMMETS ..... 57  
 DASH INSULATORS ..... 181  
 DASH KNOBS ..... 58, 59, 61, 108, 123  
 DASH PANELS ..... 60-62, 108  
 DASH PLASTIC ..... 60, 61  
 DASH SWITCH (DIMMER) ..... 84  
 DASH TRIM ..... 60  
 DATA PATENT PLATES ..... 124  
 DECALS ..... 136, 225  
 DECK EMBLEM ..... 83  
 DECK PANEL ..... 95, 147, 148, 203  
 DECK LID BUMPER ..... 185  
 DECK LID HANDLE ..... 83, 84  
 DECK LID HANDLE BASE ..... 84  
 DECK LID HANDLE PAD ..... 84  
 DECK LID HINGE ..... 186  
 DECK LID LATCH ..... 84  
 DECK LID LIGHT SOCKET ..... 83  
 DECK LID SEAL ..... 185  
 DECK LID STRIKER PLATE ..... 169  
 DECK LID SUPPORT ..... 186  
 DEFROSTER HOSE ..... 122  
 DEFROSTER KNOB ..... 123  
 DEFROSTER NOZZLE ..... 122  
 DIAL FACE GLASS (RADIO) ..... 125  
 DIAL FACE (RADIO) ..... 125  
 DIFFERENTIAL ..... 21 TO 23, 263  
 DIFFERENTIAL COVER PLATE ..... 178  
 DIMMER SWITCH ..... 80  
 DIP STICK ..... 36, 214, 215, 263  
 DIP STICK TUBE BOSS ..... 31  
 DISC BRAKE ..... 246, 247, 257, 258  
 DISTRIBUTOR BOOT ..... 70  
 DISTRIBUTOR CAP ..... 70  
 DISTRIBUTOR GASKET ..... 70  
 DISTRIBUTOR PARTS ..... 70, 71  
 DISTRIBUTOR PLUG ..... 107  
 DIVISION BAR (WINDSHIELD) ..... 71  
 DOME LAMP ..... 85  
 DOME LAMP LENS ..... 85  
 DOME LAMP SWITCH PLATE ..... 85  
 DOOR ARM RESTS ..... 169  
 DOOR ASSIST STRAPS ..... 162  
 DOOR BUMPERS ..... 158  
 DOOR CHECK ARM KITS ..... 162  
 DOOR CHECK ARM STRAPS ..... 162

DOOR DOVETAIL ..... 140  
 DOOR EDGE MIRRORS ..... 116  
 DOOR ESCUTCHEON PADS ..... 189-191  
 DOOR GLASS SEAL ..... 155, 156, 168  
 DOOR HANDLES (INSIDE) ..... 187 TO 189, 205  
 DOOR HANDLES (OUTSIDE) ..... 192, 193  
 DOOR HANDLE PADS ..... 193  
 DOOR HANDLE PINS ..... 189  
 DOOR HANDLE SETS ..... 187 TO 189  
 DOOR HINGE PINS ..... 131, 158  
 DOOR HINGES ..... 141  
 DOOR HINGE (GLOVE BOX) ..... 154  
 DOOR HINGE MIRROR ..... 116, 117  
 DOOR JAM SEALS ..... 163, 164  
 DOOR LATCHES ..... 141  
 DOOR LATCH PULL ..... 141, 162  
 DOOR LOCK ESCUTCHEON ..... 190  
 DOOR LOCK (OUTSIDE) ..... 162  
 DOOR MOULDINGS ..... 107  
 DOOR PANELS ..... 180  
 DOOR PANEL CLIPS ..... 129  
 DOOR PANEL SPRING ..... 190  
 DOOR PARTS ..... 140, 141  
 DOOR PATCH PANELS ..... 139, 140, 147, 148  
 DOOR PULLS ..... 162  
 DOOR REGULATOR ..... 161  
 DOOR SCUFF PLATES ..... 159  
 DOOR SEALS & RETAINER CHANNELS ..... 163, 164  
 DOOR SEAL (BACK EDGE) ..... 164  
 DOOR SEAL (HINGE) ..... 163  
 DOOR SEAL (LOWER) ..... 163  
 DOOR SEAL (UPPER) ..... 163  
 DOOR SPRING ..... 131, 141, 190  
 DOOR STRAP BRACKET ..... 162  
 DOOR STRIKER PAD ..... 140  
 DOOR STRIKER PLATES ..... 140  
 DOOR TRIM ..... 107  
 DOOR WINDOW CHANNEL KITS ..... 155 TO 158  
 DOOR WINDOW FRAME SEAL ..... 152  
 DOOR WINDOW RETAINER ..... 155 TO 157  
 DOOR WINDOW TRIM PANEL ..... 180  
 DOVETAILS ..... 140  
 DRAG LINK ..... 17, 252  
 DRAG LINK SEAL ..... 17  
 DRIVESHAFT PARTS ..... 23  
 DRIVESHAFT YOKE ..... 23  
 DROPPED AXLE ..... 245, 250  
 DUSTER ..... 109

## E

EDGE SEAL (DOOR) ..... 164  
 ELECTRICAL COMPONENTS (STREET ROD) ..... 205, 206, 262  
 ELECTRIC WIPER MOTORS ..... 110, 111  
 EMBLEM (FENDER) ..... 94  
 EMBLEM (GRILLE) ..... 45, 48, 49  
 EMBLEM (HOOD) ..... 48, 98, 99  
 EMBLEM (TRUNK) ..... 83  
 EMERGENCY BRAKE CABLES ..... 14, 15  
 EMERGENCY BRAKE HANDLES ..... 15  
 EMERGENCY CABLE BOOT ..... 14  
 EMERGENCY CABLE BRACKET ..... 13  
 EMERGENCY CABLE GROMMET ..... 12, 13, 57  
 EMERGENCY CABLE GUIDE ..... 13  
 ENGINE ADAPTERS ..... 42  
 ENGINE SPECIFICATION BOOKS ..... 220 TO 226  
 ENGINE CROSSMEMBERS (STREET ROD) ..... 212, 246, 248  
 ENGINE MOUNTS (STREET ROD) ..... 212, 261  
 ENGINE OIL COOLER ..... 260  
 ENGINE PARTS ..... 31 TO 36  
 ENGINE SPLASH PANS ..... 36  
 ENGINE WIRING ..... 67  
 ESCUTCHEON (DOOR HANDLE) ..... 190, 191  
 ESCUTCHEON (DOOR LOCK) ..... 190  
 ESCUTCHEON (VENT WINDOW) ..... 190  
 ESCUTCHEON (WINDOW CRANK) ..... 191  
 EXHAUST DEFLECTORS ..... 122  
 EXHAUST MANIFOLDS ..... 56  
 EXHAUST PIPES ..... 27, 28  
 EXHAUST SYSTEM ..... 27, 28  
 EXHAUST SYSTEM (STREET ROD) ..... 263

## F

FAN ASSEMBLY ..... 51, 62, 260  
 FAN BELTS ..... 51  
 FAN SHROUD (STREET ROD) ..... 43  
 FEMALE DOVETAILS ..... 140  
 FENDER APRON ..... 93, 94, 195, 199  
 FENDER APRON BOLTS ..... 93, 129  
 FENDER APRON BUMPER ..... 94  
 FENDER BOLT KIT ..... 92, 134  
 FENDER BOOTS (REAR) ..... 94  
 FENDER BRACES ..... 92, 94  
 FENDER BRACE PANEL ..... 93, 94  
 FENDER CLAMP ..... 93  
 FENDER-TO-COWL SEAL ..... 93  
 FENDER EMBLEM ..... 94  
 FENDER GROMMET ..... 120  
 FENDER GUARD ..... 94  
 FENDER MOULDINGS ..... 92



FENDER PANELS (INNER) ..... 94  
 FENDERS ..... 94, 195 to 199  
 FENDER PATCH PANELS ..... 95  
 FENDER SKIRTS (FIBERGLASS) ..... 200  
 FENDER SKIRT SEALS ..... 122  
 FENDER TRIM ..... 92  
 FENDER WELTING ..... 93  
 FENDER WELT (STAINLESS) ..... 93  
 FIBERGLASS BODIES ..... 194  
 FIBERGLASS DASH INSULATORS ..... 181  
 FIBERGLASS GRILLES ..... 201  
 FIBERGLASS FENDERS ..... 195 to 199  
 FIBERGLASS PARTS ..... 145, 194 to 204  
 FINGER PULL (WINDSHIELD) ..... 144  
 FIREWALL COVER CLIP ..... 181  
 FIREWALL GROMMET ..... 57  
 FIREWALL INSULATION ..... 181  
 FIREWALL SEAL ..... 138, 210  
 FIREWALL (STEEL) ..... 210  
 FLATHEAD SPEED EQUIPMENT ..... 42  
 FLOORBOARD SEALS ..... 137, 138  
 FLOORBOARDS ..... 172, 210  
 FLOOR COVER (BATTERY) ..... 172, 178  
 FLOOR COVER (TRANSMISSION) ..... 178  
 FLOOR MATS ..... 179  
 FLOOR MAT CLIP ..... 129, 179  
 FLOOR PAN ..... 147, 227-229  
 FLOOR PLUG ..... 138  
 FLOOR SEAL (STEERING TUBE) ..... 137  
 FLOOR SEAL (TRANSMISSION) ..... 137  
 FLOOR SHIFTER (STREET ROD) ..... 283  
 FLYWHEEL RING GEAR ..... 35  
 FOG LAMPS ..... 91  
 FOOT REST ..... 57  
 FORD PORCELAIN EMBLEM ..... 48  
 FORD PARTS TAGS ..... 124  
 FORD SCRIPT (HOOD) ..... 98, 99  
 FORD SIGN ..... 124  
 FRAME - STREET ROD ..... 233, 242, 243  
 FRAME BOXING PLATE ..... 264  
 FRAME HORN ..... 26  
 FRAME HORN COVERS ..... 95, 200  
 FRAME PAD ..... 25  
 FRAME PARTS ..... 25, 26  
 FRAME WEBBING ..... 25  
 FRAME (WINDSHIELD) ..... 142  
 FRAME WIRE CLIP ..... 69  
 FRONT AXLE ..... 16, 17  
 FRONT SUSPENSION (STREET ROD) ..... 245-251  
 FRONT FENDERS (FIBERGLASS) ..... 195 to 199  
 FUEL GAUGE ..... 54  
 FUEL GAUGE LIQUID ..... 54, 64  
 FUEL LINE ..... 55  
 FUEL PUMP ..... 55  
 FUEL SYSTEMS ..... 53 to 56  
 FUEL TANK ..... 53, 216  
 FUEL TANK-TO-SENDING UNIT ADAPTERS ..... 211

**G**

GARNISH MOULDING ..... 143, 145, 203  
 GARNISH MOULDING INSERTS ..... 145  
 GAS APRON CHANNEL SEAL KIT ..... 95  
 GAS CAPS ..... 53, 211  
 GAS GAUGE COVER ..... 53  
 GAS LID BUMPER ..... 53, 103  
 GAS NECK CLAMP ..... 53  
 GAS NECK GROMMET ..... 54  
 GAS NECK HOSE ..... 53  
 GAS PEDAL ..... 57  
 GAS PEDAL ROD ..... 57  
 GAS SENDER GASKET ..... 54  
 GAS SENDER FLOAT ..... 54  
 GAS TANK ..... 53, 216  
 GAS TANK BOLT ..... 53  
 GAS TANK COVER ..... 96  
 GAS TANK COVER (FIBERGLASS) ..... 200  
 GAS TANK COVER SCREW ..... 132  
 GAS TANK PAD ..... 55  
 GAS TANK PARTS ..... 53 to 55  
 GAS TANK SEALER ..... 53, 216  
 GAS TANK SENDING UNIT ..... 54, 211  
 GASKET, COWL VENT ..... 138  
 GASKET, DECK LID ..... 94  
 GASKET, DISTRIBUTOR ..... 70  
 GASKET, HEADLIGHT ..... 75, 76  
 GASKET, HOOD ORNAMENT ..... 50, 103  
 GASKET, INSTRUMENT PANEL ..... 54  
 GASKET, LICENSE BRACKET ..... 80  
 GASKET, LICENSE LIGHT ..... 80  
 GASKET, PARKING LIGHT ..... 77  
 GASKET, STEERING BOX ..... 18  
 GASKET, TAIL LIGHT ..... 81  
 GAUGE FACES ..... 54, 55, 109  
 GAUGE, TEMPERATURE ..... 84  
 GAUGES (STREET ROD) ..... 262  
 GEAR OIL ..... 218  
 GEAR SHIFT BOOT ..... 40, 137

GEAR SHIFT GROMMET ..... 39, 40  
 GEAR SHIFT INDICATOR ..... 207  
 GEAR SHIFT KNOBS ..... 39, 59  
 GEAR SHIFT REPAIR KIT ..... 40  
 GENERATOR BELTS ..... 51  
 GENERATOR PARTS ..... 63, 206  
 GLASS BUMPER ..... 158  
 GLASS PATTERNS ..... 142  
 GLASS SETTING TAPE ..... 143  
 GLOVE BOX ..... 154  
 GLOVE BOX DOOR ..... 108, 202  
 GLOVE BOX DOOR BUMPER ..... 154  
 GLOVE BOX DOOR HINGE ..... 154  
 GLOVE BOX DOOR REPAIR KIT ..... 154  
 GLOVE BOX DOOR SPRING ..... 154  
 GLOVE BOX DOOR STOP ..... 154  
 GLOVE BOX LOCK ..... 154  
 GLUE, RUNNING BOARD COVER ..... 95, 218  
 GLUE, WEATHERSTRIP ..... 185, 218  
 GRAVEL DEFLECTOR ..... 119, 120, 204  
 GREASE FITTINGS ..... 15, 51, 133  
 GREYHOUND RADIATOR ORNAMENTS ..... 49  
 GRILLE BARS ..... 44, 45, 47  
 GRILLE BUMPERS ..... 120  
 GRILLE CENTER ..... 44, 45, 50  
 GRILLE CLIPS ..... 44, 80, 129  
 GRILLE COMPONENTS ..... 44 to 50, 209  
 GRILLE, DELUXE ..... 46  
 GRILLE EMBLEM ..... 45, 48, 49, 76  
 GRILLE GUARDS ..... 120  
 GRILLE GUARD STIFFENER ..... 120  
 GRILLE HARDWARE KIT ..... 130  
 GRILLE INSERTS ..... 46, 47, 209  
 GRILLE MOULDING CLIPS ..... 50, 106, 129  
 GRILLE MOULDINGS ..... 50, 106  
 GRILLE ORNAMENTS ..... 45, 48  
 GRILLE PAD ..... 120  
 GRILLE PAN ..... 45, 47, 52  
 GRILLE PAN BUMPER ..... 120  
 GRILLE PARTS ..... 44 TO 50, 209  
 GRILLE SCREEN ..... 45  
 GRILLE SCRIPTS ..... 213  
 GRILLE SHELL ..... 46, 201, 209  
 GRILLE SHELL GROMMET ..... 88  
 GRILLE SHELL ORNAMENTS ..... 48, 49  
 GRILLE, STANDARD ..... 48  
 GRILLE SUPPORT ..... 44, 47, 52  
 GRILLE TRIM ..... 44 to 50, 106  
 GRILLE-TO-FENDER APRON ..... 50  
 GRILLE VENT PANELS ..... 94  
 GROMMETS ..... 57  
 GUARD, BUMPER ..... 119  
 GUARD, FENDER ..... 94  
 GUSSET PLATE ..... 178

**H**

HALOGEN REFLECTOR KIT ..... 75  
 HANDLE, COWL VENT ..... 138  
 HANDLES (DECK LID) ..... 83, 84  
 HANDLES, DOOR ..... 187 to 193  
 HANDLE, DOOR OUTSIDE ..... 192, 193  
 HANDLE, PULL ..... 162  
 HANDLE, WINDSHIELD ..... 183  
 HEAD GASKETS ..... 30  
 HEADER BRACKET ..... 151  
 HEADER BUMPER ..... 153  
 HEADER SEAL ..... 145, 153  
 HEADER STRIP, METAL ..... 144  
 HEADLAMP ..... 74  
 HEADLAMP ADAPTER ..... 74  
 HEADLAMP BARS ..... 76  
 HEADLAMP BOLTS ..... 76, 132  
 HEADLAMP BUCKETS ..... 73  
 HEADLAMP CLIP ..... 76  
 HEADLAMP CONDUIT ..... 88  
 HEADLAMP CONDUIT REPAIR ..... 88  
 HEADLAMP GROMMET ..... 88  
 HEADLAMP LENS ..... 76  
 HEADLAMP PADS ..... 76  
 HEADLAMP PARTS ..... 73 to 76  
 HEADLAMP PLUG ..... 88  
 HEADLAMP, QUARTZ BULB ..... 74  
 HEADLAMP REFLECTOR ..... 75  
 HEADLAMP PIMS ..... 75  
 HEADLAMP RIM REPAIR KIT ..... 72, 132  
 HEADLAMP RIM SCREWS ..... 75, 132  
 HEADLAMP, SEALED BEAM ..... 73, 74  
 HEADLAMP SHELL GROMMET ..... 88  
 HEADLAMP SHELL REPAIR ..... 72, 132  
 HEADLAMP STAND ..... 76  
 HEADLAMP WIRE ..... 66, 67  
 HEADLAMP WIRE CROSSOVER CHANNEL ..... 66  
 HEADLINER ..... 180  
 HEATER ..... 122, 123, 205  
 HEATER HOSE ..... 122  
 HEATER HOSE BRACKET ..... 91  
 HEATER HOSE CLAMPS ..... 122

HEATER HOSE CONNECTOR ..... 91, 122  
 HEATER KNOB ..... 123  
 HEATER PARTS ..... 91, 122, 123  
 HIGH BEAM JEWEL ..... 84  
 HINGE, DOOR SEAL ..... 163  
 HINGE PAD, HOOD ..... 103  
 HINGE PINS ..... 131, 158  
 HINGES (TRUNK LID) ..... 186  
 HOG RINGS ..... 165  
 HOOD ARM SPRING ..... 103  
 HOOD BOLTS ..... 99  
 HOOD BRACKETS ..... 47, 102  
 HOOD BUMPER KITS ..... 105  
 HOOD CENTER ..... 102, 103  
 HOOD CLIPS ..... 103  
 HOOD EMBLEMS ..... 49, 98, 99  
 HOOD HANDLES ..... 49, 102, 103  
 HOOD HANDLE & LATCH MOUNTING KIT ..... 135  
 HOOD HANDLE PIN ..... 49  
 HOOD HANDLE SPRING BRACKET ..... 102  
 HOOD HINGE BRACKETS ..... 47, 209, 263  
 HOOD HINGE ..... 103, 209  
 HOOD HINGE HARDWARE KIT ..... 105  
 HOOD HINGE PAD ..... 103  
 HOOD LACE ..... 104  
 HOOD LATCHES ..... 103, 209, 263  
 HOOD LATCH CLIP ..... 103  
 HOOD LATCH SPRINGS ..... 103  
 HOOD MOULDING CLIPS ..... 129  
 HOOD ORNAMENTS ..... 48, 49, 98, 99, 103  
 HOOD ORNAMENT BASE PADS ..... 50, 103  
 HOOD ORNAMENT MOUNTING KIT ..... 49  
 HOOD PARTS ..... 98 to 108, 209  
 HOOD PULL GROMMET ..... 57  
 HOOD RELEASE HANDLE ..... 49  
 HOOD RELEASE KIT ..... 264  
 HOOD SAFETY CATCH ..... 106  
 HOODS ..... 99 to 101  
 HOOD SIDE MOULDINGS ..... 102, 103, 106  
 HOOD STOP BRACKETS ..... 106  
 HOOD SUPPORT ..... 102, 209  
 HOOD SUPPORT ARM ..... 103  
 HOOD TRIM ..... 50, 102, 103, 106  
 HORN BOLT ..... 86  
 HORN BRACKETS ..... 86  
 HORN BUTTON ..... 20  
 HORN BUTTON CUSHION ..... 20  
 HORN BUTTON SPRING ..... 19  
 HORN BUTTON WIRE ..... 20, 68  
 HORN COVER ..... 85, 86  
 HORN GRILLE ..... 86  
 HORN GRILLE PAD ..... 86  
 HORN GROMMET ..... 86  
 HORN/LIGHT SWITCH ROD ..... 20  
 HORN MOTOR WIRING ..... 67, 86  
 HORN RODS ..... 20  
 HORN SCREEN ..... 86  
 HORN TAG ..... 86  
 HORN WIRE ..... 20, 68, 86  
 HORNS ..... 20, 85, 86  
 HOSE CLAMPS ..... 51, 53  
 HOSE, RADIATOR ..... 51  
 HUBCAPS ..... 6, 7  
 HUB PARTS ..... 8 to 10  
 HYDEM WELT ..... 160  
 HYDRAULIC BRAKE ADAPTER KIT ..... 15

**I**

IGNITION CYLINDER ..... 20  
 IGNITION KEYS ..... 20, 162  
 IGNITION LOCK SHIM ..... 20  
 IGNITION POINTS ..... 70  
 IGNITION RESISTOR ..... 71  
 IGNITION SWITCH ..... 20  
 IGNITION SWITCH PLATES ..... 66  
 INDEPENDENT FRONT SUSPENSION ..... 248-249  
 INSERT, GARNISH MOULDING ..... 145  
 INSIDE REARVIEW MIRRORS ..... 114, 115  
 INSTRUMENT GAUGE GLASS ..... 64  
 INSTRUMENT PANEL ..... 60, 108, 206  
 INSTRUMENT PANEL DIMMER SWITCH ..... 84  
 INSTRUMENT PANEL FACE SETS ..... 109  
 INSULATION, BODY ..... 181  
 INSULATION, FIREWALL ..... 181  
 INTAKE MANIFOLD GASKET ..... 35  
 INTAKE MANIFOLD WASHER ..... 133  
 INTERIOR TRIM SCREW KITS ..... 130

**K**

KICK PANELS ..... 180  
 KICK PANEL RETAINERS ..... 180  
 KICK PANEL TRIM ..... 180  
 KICKDOWN KITS ..... 214, 215  
 KNOB PINS ..... 16, 250  
 KNOB, ANTENNA ..... 127

# INDEX

KNOB, ASH TRAY ..... 61  
 KNOB, CIGAR LIGHTER ..... 90  
 KNOB, CONVERTIBLE TOP ..... 153  
 KNOB, COWL VENT ..... 59  
 KNOBS (DASH) ..... 58, 59  
 KNOB, DEFROSTER ..... 123  
 KNOB, GEAR SHIFT ..... 39, 59  
 KNOB, HEATER ..... 123  
 KNOB, RADIO ..... 125  
 KNOB, WINDOW CRANK ..... 183, 190

## L

LADDER BAR KITS ..... 212  
 LATCH, TRUNK ..... 84  
 LENS, BLUE DOT ..... 81  
 LENS, COWL LIGHT ..... 78  
 LENS, DECK BASE ..... 81  
 LENS, DOME LIGHT ..... 85  
 LENS, HEADLIGHT ..... 76  
 LENS, LICENSE PLATE LIGHT ..... 80, 81  
 LENS, PARKING LIGHT ..... 77  
 LENS, TAIL LIGHT ..... 81  
 LICENSE HOLDER (FRONT) ..... 25, 82  
 LICENSE LAMP ..... 83  
 LICENSE LENS CLIP ..... 80  
 LICENSE LIGHT ..... 83, 263  
 LICENSE PLATE BACK ..... 213  
 LICENSE PLATE BOLT ..... 82  
 LICENSE PLATE BRACKET ..... 82  
 LICENSE PLATE FRAMES ..... 83, 263  
 LICENSE PLATE LIGHT LENS ..... 80, 81  
 LICENSE PLATE PAD, GASKET ..... 81, 84  
 LIGHT BULB ..... 74, 81, 211  
 LIGHT, COWL ..... 77, 78  
 LIGHT, HEAD ..... 74 to 76  
 LIGHT, PARKING ..... 77  
 LIGHT SWITCH BODY ..... 66  
 LIGHT SWITCH/HORN ROD ..... 20  
 LIGHT, TAIL ..... 78, 79, 208  
 LIGHTERS ..... 90, 91, 108  
 LOCK CYLINDER, DOOR ..... 162  
 LOCK, GLOVE BOX ..... 154  
 LOCKING GAS CAP ..... 53  
 LOOM, WIRE CONDUIT ..... 67, 69, 88, 213  
 LOWER DOOR SEAL ..... 163  
 LUG WRENCH ..... 109  
 LUGGAGE RACKS ..... 124  
 LUGGAGE RACK EMBLEM ..... 124

## M

MAIN BEARINGS ..... 34  
 MALE DOVETAILS ..... 140  
 MANIFOLD (EXHAUST) ..... 56  
 MAP CASE ..... 109  
 MASTER CYLINDER ..... 13, 269  
 MASTER CYLINDER COVER PLATE ..... 138  
 MASTER CYLINDER MOUNT BRACKET ..... 211  
 MASTER CYLINDER REPAIR KIT ..... 11  
 METAL TOP MOULDING ..... 160  
 MIRRORS ..... 114 to 117, 205  
 MIRROR, BRACKET INTERIOR ..... 115  
 MIRROR, DOOR HINGE ..... 116, 117  
 MIRROR, EXTERIOR ..... 116, 117, 205  
 MIRROR, INTERIOR ..... 114, 115, 205  
 MIRROR HEAD, DOOR ..... 116, 117  
 MIRROR HEAD, INTERIOR ..... 116  
 MOTOR MOUNTS (FRONT) ..... 31, 212, 261  
 MOTOR MOUNTS (REAR) ..... 32  
 MOULDINGS (BODY) ..... 107  
 MOULDING CLIP KITS ..... 129  
 MOULDING (TOP) ..... 160  
 MUFFLER ..... 27  
 MUFFLER SUPPORT ..... 28

## O

OIL CHEX GAUGE ..... 84  
 OIL COOLER ..... 260  
 OIL FILLER CAPS ..... 36  
 OIL GAUGE ..... 54, 64  
 OIL PAN GASKET SET ..... 36  
 OIL PUMP ..... 36  
 OPERA SEAT BUMPER ..... 165  
 OUTSIDE REARVIEW MIRRORS ..... 116, 117, 205  
 OVERHAUL GASKET SETS ..... 30

## P

PACKAGE TRAY (WOOD) ..... 171  
 PAD, COWL LIGHT ..... 78  
 PAD, HORN GRILLE ..... 86  
 PAD, RUMBLE STEP ..... 149  
 PAINT, ENGINE ..... 31, 218  
 PAINT, STEERING WHEEL ..... 19  
 PANEL, DASH ..... 60-62, 106, 205  
 PANHARD BAR ..... 249, 256  
 PARALLEL LINK ..... 249  
 PARKING LAMPS ..... 77  
 PARKING LAMP BOOT ..... 77

PARKING LAMP LENS ..... 77  
 PARKING LAMP LENS CLIP ..... 77  
 PARKING LAMP PAD ..... 77  
 PARKING LAMP WIRE ..... 77  
 PATCH PANELS ..... 95, 139, 140, 147, 227-229  
 PATENT DATA PLATES ..... 124  
 PEDAL BUMPERS ..... 14, 137  
 PEDAL COVER PLATES ..... 178  
 PEDAL PADS ..... 14  
 PEDAL SEALS ..... 137  
 PEEP MIRRORS ..... 116, 117  
 PICKUP BED PARTS ..... 172 to 177  
 PICKUP BEDS ..... 173  
 PICKUP BED SIDE PANELS ..... 175  
 PICKUP BED STRIPS ..... 176  
 PIN, DOOR HANDLE ..... 189  
 PISTON RINGS ..... 32, 33  
 PISTONS ..... 32  
 PITMAN ARM ..... 18, 252  
 PLUG, ANTENNA HOLE ..... 127  
 PLUG WIRES ..... 71  
 POLY-RIDE ..... 251  
 PORCELAIN GRILLE EMBLEM ..... 48  
 POWER ACCESSORY BLOCK ..... 207  
 POWER BRAKE ..... 258  
 POWER WINDOW KITS ..... 213

## Q

QUAIL RADIATOR ORNAMENT ..... 49  
 QUARTER GLASS RUBBER ..... 184  
 QUARTER MOULDINGS ..... 107  
 QUARTER PANEL BRACES ..... 139  
 QUARTER PATCH PANELS ..... 139  
 QUARTER TOP PADS ..... 153  
 QUARTZ BULB ..... 74

## R

RACK & PINION ..... 252  
 RADIATOR BOLT KIT ..... 43, 52  
 RADIATOR CAPS ..... 43, 260  
 RADIATOR CAP REPAIR KIT ..... 43, 49  
 RADIATOR FAN SHROUD ..... 43  
 RADIATOR/FENDER BRACKET ..... 43, 94  
 RADIATOR GRILLE PAN ..... 50, 52, 98  
 RADIATOR GRILLE SHIELD ..... 52  
 RADIATOR HOSE ..... 51  
 RADIATOR HOSE CLAMP ..... 51  
 RADIATOR HOSE, LOWER ..... 51  
 RADIATOR HOSE, UPPER ..... 51  
 RADIATOR OVERFLOW TANKS ..... 260  
 RADIATORS ..... 43, 260  
 RADIATOR SHELL LACING ..... 104  
 RADIATOR SHELL MOUNTING ..... 135  
 RADIATOR SHROUD SEAL ..... 52  
 RADIATOR SPLASH APRONS ..... 98, 200  
 RADIATOR SUPPORT RODS ..... 44  
 RADIATOR SUPPORT ROD BRACKET ..... 44  
 RADIO ANTENNAES ..... 126, 127  
 RADIO CHANGER BUTTON ..... 125  
 RADIO COVER ..... 125, 209  
 RADIO DIAL ..... 125  
 RADIO DIAL BEZEL ..... 125  
 RADIO DIAL FACE ..... 125  
 RADIO DIAL FACE GLASS ..... 125  
 RADIO INSTALLATION BOOK ..... 126  
 RADIO KNOB ..... 108, 125  
 RADIO MOUNTING HOOK ..... 126  
 RADIO PANEL ..... 61, 108, 125  
 RADIO PARTS ..... 125 to 127  
 RADIO NUT ..... 126  
 RADIO SPEAKER BOOT ..... 126  
 RADIO SPEAKER CLOTH ..... 126  
 RADIO SPEAKER GRILLE ..... 61, 127  
 RADIO STATION SELECTOR ..... 125  
 RADIUS ROD ..... 244  
 RADIUS ROD BUSHING ..... 17  
 REAR AXLE ..... 22  
 REAR AXLE ASSEMBLIES (STREET ROD) ..... 253  
 REAR END COVER ..... 178  
 REAR FENDERS (FIBERGLASS) ..... 195 to 199  
 REAR QUARTER WINDOW RUBBER ..... 184  
 REAR SUSPENSION (STREET ROD) ..... 253-256  
 REAR WINDOW BUMPER ..... 151, 154  
 REAR WINDOW DRAIN ..... 148  
 REAR WINDOW SEAL ..... 184  
 REAR WINDOW STRAP ..... 151  
 REFLECTOR, HEADLAMP ..... 75  
 REGULATOR HANDLE ..... 189  
 REGULATORS (WINDOW) ..... 181  
 REGULATOR, WINDSHIELD ..... 182  
 RESISTOR ..... 71  
 RESTORATION SUPPLIES ..... 218  
 RIM LINERS ..... 10

RING & PINION GEARS ..... 21  
 RIVETS ..... 129  
 ROADSTER TOP IRONS ..... 151, 204  
 ROCKER PANELS ..... 139  
 ROD BEARINGS ..... 33  
 ROOF RIB WOOD KITS ..... 171  
 ROTOR (DISTRIBUTOR) ..... 71  
 RUBBER (WINDSHIELD) ..... 182  
 RUMBLE BUMPERS ..... 149, 185  
 RUMBLE HANDLES ..... 83, 150  
 RUMBLE HANDLE PAD ..... 84  
 RUMBLE HINGE KITS ..... 149  
 RUMBLE LATCH ..... 84  
 RUMBLE LID SEAL ..... 185  
 RUMBLE SEAT PARTS ..... 149, 150  
 RUMBLE SEAT RAIN GUTTERS ..... 148  
 RUMBLE STEP ..... 149  
 RUMBLE STEP BRACKET ..... 149  
 RUMBLE TRIP LEVER ..... 150  
 RUNNING BOARD ..... 95 to 97  
 RUNNING BOARD BOLT ..... 95, 134  
 RUNNING BOARD BRACES ..... 97  
 RUNNING BOARD COVERS ..... 97  
 RUNNING BOARD COVER GLUE ..... 95, 218  
 RUNNING BOARD PAD ..... 25  
 RUNNING BOARD MOULDINGS ..... 97  
 RUNNING BOARD TRIM CLIP KIT ..... 97  
 RUNNING BOARDS (FIBERGLASS) ..... 200  
 RUNNING BOARD STEP PLATES ..... 95

## S

SAFETY SWITCH (NEUTRAL) ..... 207  
 SAGINAW STEERING MOUNT ..... 208  
 SCREEN, COWL VENT ..... 138  
 SCREEN, HORN ..... 86  
 SCREW, COWL LIGHT ..... 78, 132  
 SCREW, DASH ..... 136  
 SCREW, DOOR HANDLE ..... 130  
 SCREW, DOOR HINGE ..... 131  
 SCREW, DOOR SCUFF ..... 132  
 SCREW, DOVETAIL ..... 131  
 SCREW, FLOORBOARD ..... 133  
 SCREW, FRONT FENDER ..... 134  
 SCREW, HEADLAMP RIM ..... 75, 132  
 SCREW, HOODLATCH ..... 135  
 SCREW KIT, INTERIOR ..... 130  
 SCREW, RADIATOR SHELL ..... 135  
 SCREW, REAR WINDOW ..... 134  
 SCREW, TAILLIGHT ..... 131  
 SCREW, WINDSHIELD FRAME ..... 133  
 SCUFF PLATES (DOOR) ..... 159  
 SEALED BEAM HEADLAMP ..... 73, 74  
 SEALED BEAM ADJUSTMENT KIT ..... 73  
 SEAT ADJUST HANDLE ..... 161  
 SEAT, BENCH (STREET ROD) ..... 164  
 SEATS (STREET ROD) ..... 164  
 SEAT FRAME SUPPORTS ..... 186  
 SEAT RELEASE PARTS ..... 161  
 SEAT SPRINGS ..... 165 to 168  
 SEAT SPRING LOCATING PIN ..... 186  
 SEAT WOOD ..... 170  
 SENDING UNIT (GAS) ..... 54, 211  
 SENDING UNIT, TEMPERATURE ..... 64  
 SHACKLE KITS ..... 28, 251  
 SHEETMETAL, BODY CHANNEL ..... 147  
 SHEETMETAL, DECK GUTTER ..... 148  
 SHEETMETAL, FLOOR ..... 147, 227-229  
 SHEETMETAL, FLOOR EXTENSION ..... 147, 227  
 SHEETMETAL, GRILLE ..... 44, 45, 47, 50  
 SHEETMETAL, PACKAGE TRAY ..... 147  
 SHEETMETAL, PATCH PANEL ..... 139, 140, 147  
 SHEETMETAL, RUMBLE RISER ..... 147  
 SHEETMETAL, SEAT ADJUSTER ..... 147  
 SHEETMETAL, SEAT FRAME ..... 147  
 SHEETMETAL, SEAT PANEL ..... 148  
 SHEETMETAL, SEAT RISER ..... 147  
 SHEETMETAL, UNDER DECK LID ..... 146  
 SHEETMETAL, UNDER SEAT ..... 147, 227-229  
 SHEETMETAL, WINDOW DRAIN ..... 148  
 SHIFT BOOT ..... 40, 137  
 SHIFT KNOB ..... 39, 59  
 SHIFT LEVER GROMMET ..... 39, 40  
 SHIFT LINKAGE REPAIR KIT ..... 40  
 SHIFTER (STREET ROD) ..... 215, 263  
 SHIMS (FRAME) ..... 25  
 SHOCK KIT ..... 121, 209, 249  
 SHOCK LINK BALL ..... 121  
 SHOCK MOUNT ..... 121, 251  
 SHOCK ABSORBER PARTS ..... 121  
 SIDE CURTIN ROD SOCKETS ..... 134  
 SIDEMOUNT MIRROR ..... 114  
 SILL PLATE, DOOR ..... 159  
 SIGRTS ..... 200  
 SOCKET, HIGH BEAM JEWEL ..... 84  
 SPARE TIRE COVER TRIM ..... 10, 122  
 SPARE TIRE COVER SEAL ..... 10  
 SPARE TIRE GROMMET ..... 10  
 SPARE TIRE HOLD-DOWN BRACKET ..... 122  
 SPARE TIRE PAD ..... 10

SPARK PLUGS ..... 72  
 SPARK PLUG LOOM ..... 72, 218  
 SPARK PLUG WIRES ..... 71  
 SPARK PLUG WIRE BOOT ..... 70  
 SPEAKER CLOTH ..... 126  
 SPEAKER GRILLE ..... 61, 127  
 SPEED EQUIPMENT (FLATHEAD) ..... 42  
 SPEEDOMETER CABLES ..... 110  
 SPEEDOMETER CABLE BRACKET ..... 110  
 SPEEDOMETER CABLE GROMMET ..... 57  
 SPEEDOMETER FACES ..... 109  
 SPEEDOMETER FACE GLASS ..... 64  
 SPINDLE ..... 246, 250  
 SPINDLE BOLT KITS ..... 16, 250  
 SPOTLIGHTS ..... 123  
 SPREADER BARS ..... 26, 263  
 SPRING, BRAKE/CLUTCH ..... 11, 14, 40, 41  
 SPRING, CLAMP ..... 28, 251  
 SPRING COVERS ..... 122  
 SPRING, COWL VENT ..... 138  
 SPRING, DOOR ..... 141  
 SPRING, DOOR PANEL ..... 190  
 SPRING (FRONT) ..... 28, 213, 251  
 SPRING, GLOVE BOX DOOR ..... 154  
 SPRING, HOOD ARM & LATCH ..... 103  
 SPRING, HORN BUTTON ..... 19  
 SPRING, LINER ..... 254  
 SPRING, MOUNTING KIT ..... 212, 254  
 SPRING PARTS ..... 28, 29, 251  
 SPRING PERCH ..... 16, 212, 251  
 SPRING, PERCH NUT ..... 18  
 SPRINGS (SEAT) ..... 165 to 168  
 SPRING, SHACKLE ..... 28, 254  
 SPRING, "U" BOLT ..... 29, 254  
 STABILIZER BAR ..... 29  
 STABILIZER BUSHING ..... 29  
 STABILIZER SWIVEL ..... 16  
 STARTER BUTTON ..... 59  
 STARTER PARTS ..... 65  
 STEERING ARM ..... 250  
 STEERING BOX PARTS ..... 17 to 19  
 STEERING COMPONENTS (STREET ROD) ..... 208, 250, 252  
 STEERING COLUMN ..... 214, 252  
 STEERING COLUMN DROPS ..... 215, 252  
 STEERING FLOOR PLATES ..... 137, 178, 215  
 STEERING GEAR ..... 252  
 STEERING SECTOR ..... 18  
 STEERING SHAFT BUSHING ..... 17  
 STEERING TUBE FLOOR PLATE ..... 137  
 STEERING TUBE SEALS ..... 137, 138  
 STEERING U-JOINTS ..... 208  
 STEERING WHEELS ..... 19, 232  
 STEERING WHEEL PAINT ..... 19, 218  
 STEP, RUMBLE ..... 149  
 STONE DEFLECTOR (BUMPER) ..... 120, 204  
 STONE GUARD ..... 94  
 STOP LIGHT SWITCH ..... 80  
 STRIKER PLATE, DECK ..... 150, 189  
 STRIKER PLATE, DOOR ..... 140  
 STRIKER PLATE PAD ..... 140  
 SUICIDE DOOR SAFETY LOCK ..... 141  
 SUN VISORS ..... 160  
 SUN VISOR ROD ..... 151, 160  
 SUN VISOR BRACKET ..... 151  
 SUSPENSION COMPONENTS (STREET ROD) ..... 245-256  
 SWITCH, DASH LIGHT ..... 84  
 SWITCH LEVER, IGNITION ..... 20  
 SWITCH, NEUTRAL SAFETY ..... 207  
 SWITCH, UNIVERSAL ..... 108  
 SWITCH PLATE, IGNITION ..... 66

**T**

T-SHIRTS ..... 230, 231, INSIDE BACK COVER  
 TAG, FORD SCRIPT ..... 124  
 TAIL GATES ..... 174  
 TAIL GATE BUMPER ..... 164  
 TAIL LAMP BRACE ..... 80  
 TAIL LAMP BRACKETS ..... 79, 80  
 TAIL LAMP CONDUIT REPAIR ..... 88  
 TAIL LAMP HALOGEN CONVERSION ..... 208  
 TAIL LAMP LENS ..... 81  
 TAIL LAMP PAD ..... 82  
 TAIL LAMP PARTS ..... 78 to 82  
 TAIL LAMP REFLECTOR ..... 80  
 TAIL LAMP RING ..... 80  
 TAIL LAMPS ..... 78, 79, 213  
 TAIL LAMP TRIM ..... 79  
 TAIL LAMP SCREWS ..... 131  
 TAIL LAMP SOCKET ..... 69  
 TAIL LAMP WIRING ..... 69  
 TAIL PIPE ..... 27  
 TANDEM WIPER ..... 112  
 TAPE, GLASS SETTING ..... 143  
 TEMPERATURE GAUGE ..... 64  
 TEMPERATURE GAUGE HOSE FITTING ..... 122  
 TEMPERATURE SENDER ..... 64  
 THERMOSTAT ..... 51  
 THERMOSTAT HOUSING ..... 260  
 THROTTLE ASSEMBLY ..... 56, 57, 205, 214

THROTTLE CABLE (STREET ROD) ..... 214  
 THROTTLE CABLE KITS ..... 62  
 THROTTLE RODS ..... 56  
 TIE RODS ..... 16, 252  
 TIE ROD CLAMP ..... 127  
 TIE ROD ENDS ..... 17, 252  
 TIE ROD JAM NUT ..... 263  
 TIE ROD SEAL ..... 17  
 TIRE COVERS ..... 10  
 TIRES ..... 10  
 TIRE COVER TRIM ..... 10  
 TIRE TUBES ..... 10  
 TOOL BAG ..... 109  
 TOP BOWS (OAK) ..... 171  
 TOP BOW PADS ..... 152  
 TOP BOW SEAL ..... 145, 153  
 TOP DECK MATERIAL ..... 160  
 TOP DECK RETAINER ..... 160  
 TOP HOLD-DOWN ..... 151, 153, 154  
 TOP IRONS ..... 151, 204  
 TOP IRON RIVET COVERS ..... 151  
 TOP KNOBS (CONVERTIBLE) ..... 153  
 TOP MATERIAL ..... 160  
 TOP MOULDINGS ..... 160  
 TOP REST BRACKET ..... 153  
 TOP REST SCREW ..... 134  
 TRAILING ARMS ..... 255  
 TRANSMISSION COVERS ..... 178  
 TRANSMISSION COVER FASTENER KIT ..... 133  
 TRANSMISSION MOUNT ..... 32  
 TRANSMISSION-TO-FLOOR SEAL ..... 137  
 TRANSMISSION PARTS ..... 37 to 41  
 TRANSMISSION SHIFTER ..... 215, 263  
 TRIM, BODY ..... 102, 107  
 TRIM CEMENT ..... 158, 218  
 TRIM CLIP KITS ..... 129, 130  
 TRIM, DASH ..... 60  
 TRIM, HOOD ..... 102, 103, 106, 107  
 TRIM, KICK PANEL ..... 160  
 TRIM RING (SPARE TIRE) ..... 10  
 TRIM, RUNNING BOARD ..... 97  
 TRIM SCREW KITS ..... 129, 130  
 TRUNK ARM SUPPORT ..... 186  
 TRUNK EMBLEM ..... 83  
 TRUNK GUSSETS ..... 148  
 TRUNK HANDLES ..... 83, 84  
 TRUNK HANDLE NUT ..... 132  
 TRUNK HANDLE PAD ..... 84  
 TRUNK HINGE ..... 186  
 TRUNK HINGE PADS ..... 186  
 TRUNK LATCH ..... 84, 170  
 TRUNK LID (FIBERGLASS) ..... 203  
 TRUNK LID BASE ..... 84  
 TRUNK LID BASE (INNER) ..... 84  
 TRUNK LID BUMPER ..... 185  
 TRUNK LID HINGES ..... 186  
 TRUNK LID LATCH ..... 84, 170  
 TRUNK LID SEAL ..... 195  
 TRUNK MAT ..... 179  
 TRUNK TOOL COVER (WOOD) ..... 172  
 TUBULAR STRUT ROD ..... 248  
 TURN SIGNAL KIT ..... 78

**U**

U-BOLT ..... 29, 251  
 U-JOINTS ..... 37, 208  
 UPHOLSTERY BUTTONS ..... 133  
 UPHOLSTERY HOG RINGS ..... 165  
 UPPER DOOR SEAL ..... 163

**V**

V-8 EMBLEM, HOOD ..... 98  
 V-8 EMBLEM, LUGGAGE RACK ..... 124  
 V-8 EMBLEM, SHELL ..... 48, 76  
 VACUUM WIPER MOTORS ..... 110, 111  
 VALVE PARTS ..... 35  
 VALVE GUIDE ..... 35  
 VENT GASKET, COWL ..... 138  
 VENT WINDOW EDGE SEAL ..... 183, 184  
 VENT WINDOW ESCUTCHEON ..... 184, 190  
 VENT WINDOW HANDLE ..... 184, 189, 205  
 VENT WINDOW REPAIR KIT ..... 184  
 VENT WINDOW RUBBER ..... 183  
 VENT WINDOW SEAL ..... 183  
 VOLTAGE CUT-OUT ..... 63  
 VOLTAGE REDUCER ..... 63, 207  
 VOLTAGE REGULATOR ..... 63  
 VOLTAGE REGULATOR PAD ..... 63

**W**

WATER PUMPS ..... 51  
 WEATHERSTRIP ADHESIVE ..... 158, 218  
 WEBBING ..... 26  
 WELTING (FENDER) ..... 93  
 WHEEL BEARINGS ..... 8 to 10

WHEEL CYLINDERS (FRONT) ..... 12  
 WHEEL CYLINDERS (REAR) ..... 13  
 WHEEL PARTS ..... 8 to 10, 217  
 WHEEL TRIM RINGS ..... 7  
 WHEEL WELLS ..... 147, 210  
 WINDLACE ..... 162  
 WINDOW CHANNEL (CONVERTIBLE) ..... 152  
 WINDOW CHANNEL (FELT) ..... 155, 156  
 WINDOW CHANNEL (METAL) ..... 157, 159  
 WINDOW CRANK ..... 187-189, 205  
 WINDOW CRANK KNOB ..... 190  
 WINDOW FELT KITS ..... 155, 156  
 WINDOW FRAME (BACK) ..... 151, 213  
 WINDOW FRAME SEAL ..... 152  
 WINDOW GLASS PATTERNS ..... 142  
 WINDOW REGULATORS ..... 161  
 WINDOW RETAINER (DOOR) ..... 155 to 158  
 WINDOW RUBBER (BACK) ..... 184  
 WINDOW RUBBER (VENT) ..... 183, 184  
 WINDOW SEAL (CONVERTIBLE) ..... 152, 153  
 WINDOW SEAL (QUARTER) ..... 184  
 WINDOW SEAL (REAR) ..... 184  
 WINDOW SHADE (BACK) ..... 161  
 WINDOW STOP ..... 158  
 WINDOW VENT, HANDLE ..... 184, 189  
 WINDSHIELD DIVISION BARS ..... 107  
 WINDSHIELD FRAME PARTS ..... 142-144  
 WINDSHIELD FRAMES ..... 142, 213  
 WINDSHIELD FRAME CLIP ..... 143  
 WINDSHIELD GARNISH MOULDING ..... 144  
 WINDSHIELD HANDLE ..... 183  
 WINDSHIELD HARDWARE ..... 143, 144  
 WINDSHIELD HINGE SEAL ..... 182  
 WINDSHIELD POST PAD ..... 144  
 WINDSHIELD REGULATOR HANDLES ..... 183  
 WINDSHIELD REGULATORS ..... 182  
 WINDSHIELD RUBBER ..... 182  
 WINDSHIELD SEAL ..... 182  
 WINDSHIELD SEALER ..... 143  
 WINDSHIELD STANCHION ..... 143, 144  
 WINDSHIELD STUD ..... 134, 144  
 WINDSHIELD SWING ARM ..... 143  
 WINDSHIELD WING NUT ..... 144  
 WINDSHIELD WIPER ARMS ..... 112, 205  
 WINDSHIELD WIPER MOTORS ..... 110, 111  
 WINDSHIELD WIPER PARTS ..... 110 to 113  
 WINDSHIELD WIPER TOWERS ..... 113  
 WINDING BRACKETS ..... 121  
 WINDING BRACKET PADS ..... 121  
 WINDING TENSION SPRING ..... 134  
 WING TIPS (BUMPER) ..... 120  
 WIPER ARMS & BLADES ..... 112, 205  
 WIPER ARM NUT ..... 111  
 WIPER MOTORS ..... 110, 111  
 WIPER SHAFT SEAL ..... 112  
 WIPER SWITCH ..... 112  
 WIPER TOWER ..... 113  
 WIPER TOWER PADS ..... 112  
 WIRE CLAMP ..... 64  
 WIRE CLIP ..... 69  
 WIRE CONNECTOR ..... 69  
 WIRE LOOM ..... 69, 72, 213  
 WIRE LOOM GROMMET ..... 68  
 WIRE PER FOOT ..... 69  
 WIRING BOARDS (STREET ROD) ..... 262  
 WIRING, CLOCK LIGHT ..... 66  
 WIRING, COIL ..... 67  
 WIRING, CONVERTIBLE TOP ..... 66  
 WIRING, COWL LIGHT ..... 67  
 WIRING, DASH ..... 68, 206  
 WIRING, DOME LIGHT ..... 69  
 WIRING, ENGINE ..... 66, 67  
 WIRING, HEADLAMP ..... 67  
 WIRING, HIGH BEAM JEWEL ..... 84  
 WIRING, HORN ..... 86  
 WIRING, HORN BUTTON ..... 20  
 WIRING, LICENSE LIGHT ..... 69  
 WIRING, OVERDRIVE ..... 69  
 WIRING, PARKING LIGHT ..... 77  
 WIRING, SPARK PLUG ..... 71  
 WIRING SYSTEM (STREET ROD) ..... 206, 207  
 WIRING, TAIL LIGHT ..... 69  
 WISHBONE SPLITTER ..... 206  
 WOOD, FLOOR BOARD ..... 172  
 WOOD, HEADER ..... 170, 171  
 WOOD, PACKAGE TRAY ..... 171  
 WOOD, ROOF RIB ..... 171  
 WOOD, SEAT FRAME ..... 170  
 WOOD, WINDOW FRAME ..... 171  
 WOOD, WINDSHIELD STRIP ..... 171  
 WORM GEAR (STEERING) ..... 17

**X**

X-MEMBER SUPPORT ..... 212

# GENERATOR

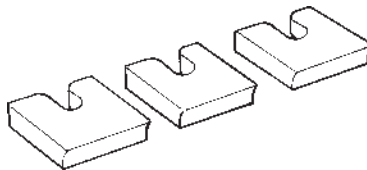
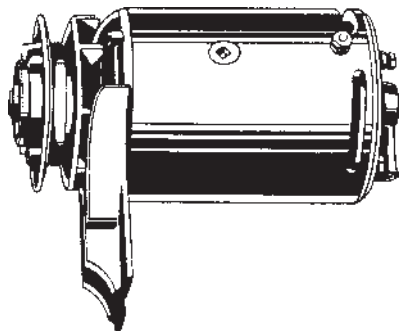

### GENERATOR BRUSH SET

1932-39 ALL (3 BRUSH)  
A-10043 SET 3.00

1940-48 (2 BRUSH)  
01A-10043 SET 4.95

### GENERATOR BRUSH SPRING

1939-48, (2 BRUSH)  
91A-10057 EACH 3.75



### GENERATOR ROLLER BEARING & RACE ASSEMBLY

1937-39  
79-10094 EACH 11.95

1940-48  
7RA-10094 EACH 9.95



### GENERATOR END BUSHING

1932-36 V-8  
18-10128 EACH 3.00

1937-48  
78-10128 EACH 2.00

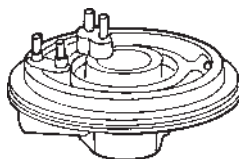

### GENERATOR REAR END PLATE

1932-39  
40-10129 EACH 29.00

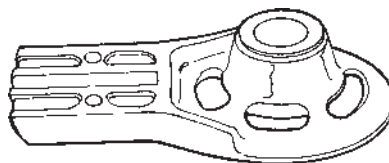

### GENERATOR POST

1937-39  
78-10139 EACH 20.00

1940-48  
21A-10139 EACH 47.50

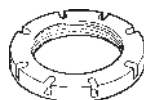

### GENERATOR POST NUT

1932 V-8  
18-10153 EACH 12.00

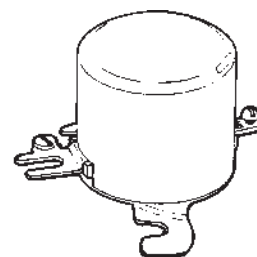

### GENERATOR CUT-OUT SWITCH

1932-39 FORD SCRIPT (FOREIGN)  
B-10505-FS EACH 55.00

1932-39 NO SCRIPT (FOREIGN)  
B-10505-F EACH 32.50

1932-39 ELECTRONIC REGULATOR  
FORD SCRIPT  
B-10505-R EACH 120.00

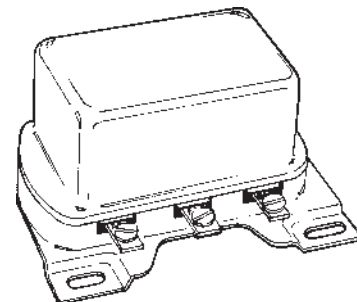

### VOLTAGE REGULATOR

1939-48 ALL  
51A-10505 EACH 64.75

12 VOLT  
B6A-10505 EACH 45.00



### CUT-OUT CONVERSION KIT

CONVERTS CUT-OUT TO DIODE  
1932-39  
A-10506-DK KIT 7.00



### VOLTAGE REDUCER, 12V TO 6V

SR-10606 EACH 17.50



### VOLTAGE REGULATOR-TO-FIREWALL GROMMET SET

1939-48 ALL  
91A-10610 SET 10.00

### REBUILT GENERATORS - EXCHANGE

ALL GENERATORS LISTED ARE FOR REPLACEMENT PURPOSES, AS SOLD BY FORD IN 1950. IF YOU REQUIRE AUTHENTICITY FOR SHOW PURPOSES, PLEASE INQUIRE AS TO MODEL AND PRICE.

1932-34 4 CYLINDER  
B-10000 EACH 225.00\*

1932 V8 (POST MOUNTING)  
18-10000 EACH 225.00\*

1933-39 3 BRUSH  
40-10000 EACH 225.00\*

1938-39 2 BRUSH  
91A-10000 EACH 225.00\*

1939-41 2 BRUSH  
01A-10000 EACH 225.00\*

1942-48 V8  
21A-10000 EACH 225.00\*

1941-47 6 CYLINDER  
1GA-10000 EACH 225.00\*

1947-48 6 CYLINDER  
7HA-10000 EACH 225.00\*

\* ALL GENERATORS PRICED EXCHANGE. NO EXCHANGE: ADD \$75. CORE CHARGE

**USE OUR TOLL FREE NUMBER  
1-800-532-1932  
OR OUR FAX NUMBER  
408-866-1934  
FOR PLACING YOUR ORDER!**

**FOR INFORMATION PLEASE  
CALL  
408-378-1935**



# BATTERY

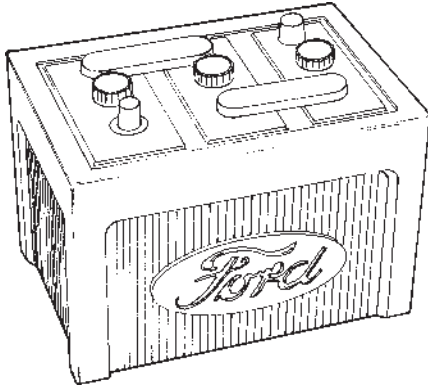

**FORD SCRIPT BATTERY**

1932-53 INQUIRE

**REPLACEMENT BATTERY**

1928-32 GROUP I 6V  
A-10655-R EACH 107.95

1934-53 GROUP II  
01A-10655 EACH 112.95



**WIRE CLAMP**

FITS ON SPARK PLUG WIRE CONDUIT FOR  
TEMP. GAUGE, IGNITION & GEN. WIRES.

1935-48  
48-10882-S SET OF 3 INQUIRE

# GAUGES

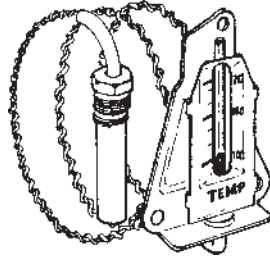

**TEMPERATURE GAUGE**

COMPLETE WITH CABLE AND SENDING  
UNIT.

1935-36  
68-10883 EACH 175.00

1937-39  
91A-10883 EACH 166.50

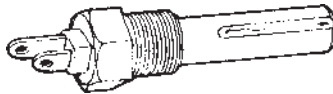

N.O.S. AVAILABLE

**TEMPERATURE SENDING UNIT**

1940-48  
LEFT HAND, DOUBLE CONTACT  
8A-10990 EACH 62.50

RIGHT HAND, SINGLE CONTACT  
8A-10884 EACH 62.50

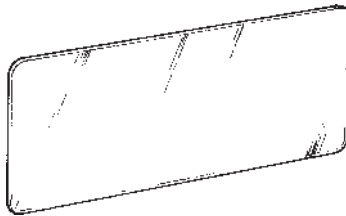

**SPEEDOMETER AND GAUGE FACE GLASS**  
N.O.S., LIMITED SUPPLY

1940 STANDARD, 40-47 PICKUP  
01A-10880-A EACH INQUIRE



**FUEL GAUGE LIQUID**

1932-36  
M-9280 EACH 5.00

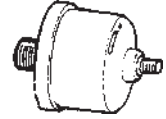
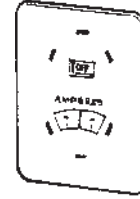

**OIL CHEX GAUGE**

U.S.A. REPRODUCTION WITH SENDING  
UNIT. NO FACE RING OR LENS.

1932  
B-10850-OC EACH INQUIRE

1933-34 PASSENGER  
40-10850-OC EACH INQUIRE

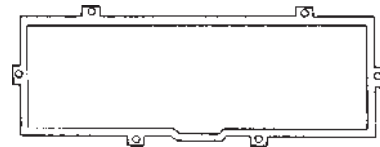

**INSTRUMENT CLUSTER BEZEL GASKET**

1940 DELUXE  
01A-10861 EACH 6.00

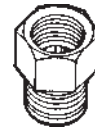

**TEMPERATURE GAUGE BULB ADAPTER**

REDUCES SIZE OF HOLE IN HEAD  
1932-39  
01A-10889 EACH 10.00

**USE OUR TOLL FREE NUMBER**  
**1-800-532-1932**  
**OR OUR FAX NUMBER**  
**408-866-1934**  
**FOR PLACING YOUR ORDER!**

**FOR INFORMATION PLEASE**  
**CALL**  
**408-378-1935**

# STARTER

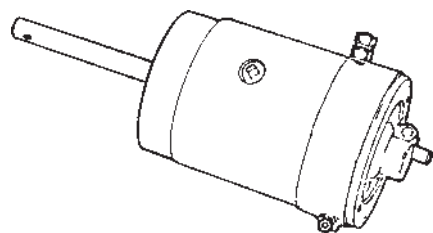

**STARTER ASSEMBLY**  
 1932-34 4 CYLINDER  
 B-11002 EACH INQUIRE

1932-48 V-8  
 18-11002 EACH INQUIRE

V-8 60  
 52-11002 EACH INQUIRE

**CORE CHARGE 50.00**

**NEW STARTER ASSEMBLY**  
 INCLUDES MODERN STARTER DRIVE

1932-48 V-8  
 18-11002-6 EACH 205.00  
 18-11002-12 EACH 205.00

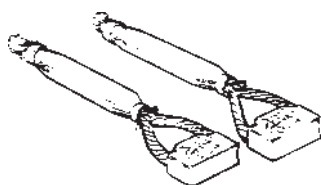

**STARTER BRUSH SET**  
 1933-48 ALL  
 18-11057 SET 7.50



**FRONT END PLATE BUSHING**  
 1932-48 ALL  
 18-11052 EACH 1.25

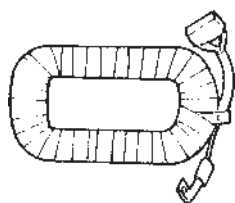

**FIELD COIL (6 VOLT)**  
 1932-48  
 LEFT HAND  
 18-11083 EACH 19.95  
 RIGHT HAND  
 18-11085 EACH 19.95



**STARTER TERMINAL SCREW BUSHING**  
 1932-48  
 18-11107 EACH INQUIRE



**REAR END PLATE BUSHING**  
 1932-48 ALL  
 B-11135 EACH 2.00

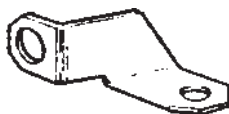

**STARTER-TO-OIL PAN SUPPORT BRACKET**  
 1939-48 V8, 41-47 6 CYLINDER  
 51A-11140 EACH 10.00

**USE OUR 800 NUMBER OR FAX NUMBER FOR PLACING YOUR ORDER!**

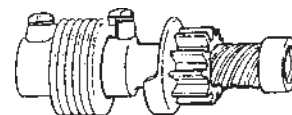

**STARTER BENDIX DRIVE**  
 1932-48 ALL (EXCEPT 60 H.P.)  
 B-11350 EACH 39.95  
 MODERN STARTER BENDIX DRIVE  
 B-11350-M EACH 29.95

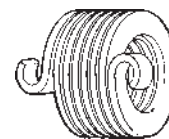

**STARTER DRIVE SPRING**  
 1932-48 ALL (EXCEPT 60 H.P.)  
 B-11375 EACH 8.50

**NEW OLD STOCK**

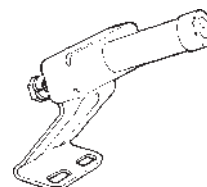

**STARTER SWITCH**  
 1932 4 CYLINDER  
 B-11450 EACH 35.00

1932-34 PASSENGER, 35-36 TRUCK  
 FOOT CONTROLLED  
 40-11450 EACH 45.00

1935-36 PASSENGER & COMM  
 48-11450 EACH 45.00



**STARTER SOLENOID**  
 1937-48 ALL  
 21A-11450 EACH (BAKELITE) 25.00

1937-48  
 01A-11450 EACH (STEEL CASE) 38.00

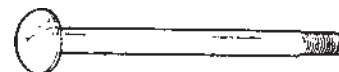

**STARTER SWITCH PUSH ROD**  
 1932-34  
 B-11470 EACH 3.00

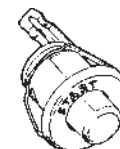

**STARTER BUTTON - CHROME**  
 1937-48 ALL  
 6A-11500-C EACH 9.50

FOR ACCURATE COLORED STARTER  
 BUTTONS SEE PAGE 59

# WIRING

**REBUILT IGNITION ASSEMBLIES AVAILABLE - INQUIRE**

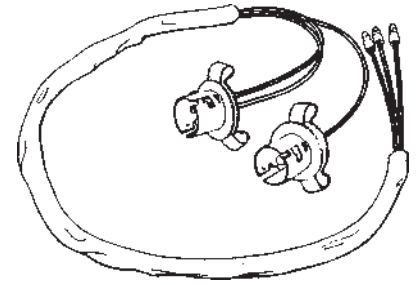
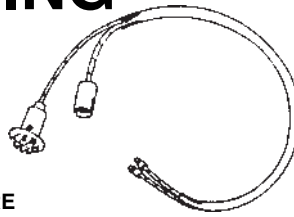

**IGNITION SWITCH OFF-ON PLATE**

1932  
B-11556 EACH  8.00

1933-34  
40-11556 EACH  8.00

1935-36  
48-11556 EACH  8.00

1937 & 40-46  
78-11556 EACH  8.00

1938-39  
81A-11556 EACH  8.00

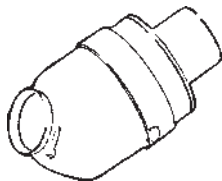

**LIGHT SWITCH BODY & HOUSING**  
1932-37 ALL  
B-11655-S SET 20.00  
1938-39 ALL  
81A-11655 SET (N.O.S.) 27.50

N.O.S. AVAILABLE - INQUIRE

**CLOCK WIRE INCLUDES BULB HOLDER**  
1937  
78-15026 EACH 19.50

1939-40  
91A-15026-C EACH 12.50  
1942-48, 2 WIRE, 2 SOCKET  
21A-15026-B EACH 15.00

1939 MERCURY  
99A-15026 EACH 16.50

1940 MERCURY  
09A-15026 EACH 15.50

1946-48, 3 WIRE, 2 SOCKET  
59A-15026-B EACH 54.00

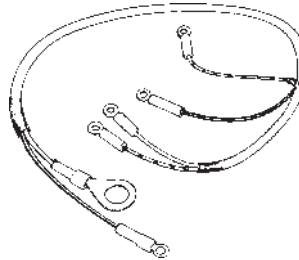

**CONVERTIBLE HARNESS**  
1946-48  
CONVERTIBLE TOP SWITCH TO  
CIRCUIT BREAKER HARNESS  
51A-14332 EACH INQUIRE

1946-48 SPORTSMAN CONVERTIBLE  
REAR QUARTER WINDOW REGULATOR  
TO COWL DASH HARNESS  
11A-14339 EACH 148.00

1946-48  
STARTER SOLOINOID TO  
PUMP SOLOINOID, 29" LONG  
51A-14506-A EACH 17.50

1946-48  
STARTER SOLOINOID TO  
PUMP SOLOINOID, 32" LONG  
51A-14506-B EACH 17.50

**TURN SIGNAL WIRE**  
1942-48 INDICATOR WIRE  
(LESS SWITCH & FLASHER)  
0A-14492 EACH 52.00

1942-48 FRONT TURN SIGNAL WIRE  
0A-14499 EACH 30.00

1942-48 DASH-TO-LEFT REAR LOOM  
BA-14435-A EACH 30.00

**HEADLIGHT SOCKETS**  
INCLUDES 10" LEADS TO CONNECT  
WITH HEADLIGHT HARNESS.  
1937-40 INCLUDE PARKING LAMP SOCKET

1932 PASSENGER  
B-13076 EACH 19.00

1933-34 PASSENGER & PICKUP  
46-13076 EACH 17.50

1935-36 PASSENGER, 35-39 PICKUP  
48-13076 EACH 19.00

1937-39 PASSENGER  
91A-13076 EACH 19.00

1940 PASSENGER, 40-41 PICKUP  
01A-13076 EACH 19.00

1941-48 PASSENGER  
11A-13076 EACH 19.00

1946-47 PICKUP  
51C-13076-B EACH 19.00



**HEADLIGHT SWITCH WIRING**  
1940 PASSENGER & PICKUP, 41  
SEDAN DELIVERY  
01A-11652-K EACH 12.50

1941-48 PASSENGER, 41-47 PICKUP  
11A-11652-K EACH 16.50

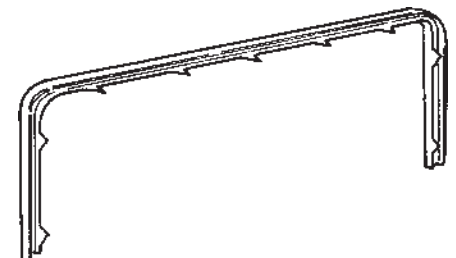

**HEADLIGHT WIRE CROSSOVER CHANNEL**  
1939-40  
91A-8005-WB EACH 40.00



**HEADLIGHT WIRING HARNESS  
ACCURATE REPRODUCTIONS**

1932 PASSENGER & PICKUP 18-11647 EACH WITH COWL LIGHTS: 18-11646 EACH	91.00 99.50
1933-34 PASSENGER & PICKUP WITH COWL LIGHT WIRE 40-11646 EACH WITH NO COWL LIGHT WIRE 40-11647 EACH	87.50 92.50
1935-36 PASSENGER & PICKUP 48-11647 EACH	98.50
1937 PASSENGER 78-11647 EACH	65.00
1938 PASSENGER 81A-11653 EACH	105.00
1939 PASSENGER, DELUXE & STD. 91A-11653 EACH	96.00
1940 PASSENGER, DELUXE & STD. 01A-11653 EACH	84.00
1941-47 PASSENGER 51A-11653-A EACH	88.00
1947-48 PASSENGER CROSSOVER WIRE, USED WITH 51A-14401-B DASH WIRE. 51A-11653-B EACH	40.00
1946-47 PASSENGER (6 CYL.) 5GA-11653 EACH	87.00
1942-47 MERCURY (IGNITION ON COLUMN) 29A-11653 EACH	108.50
1947-48 MERCURY (IGNITION ON DASH) 59A-11653 EACH	55.00
1937 PICKUP 77-11653 EACH	63.50
1938 PICKUP 81C-11647 EACH	97.00
1939 PICKUP 91C-11653 EACH	91.00
1940-46 PICKUP 01C-11653 EACH	73.00
1940-47 PICKUP (6 CYL. EXCEPT C.O.E.) 5GC-11653 EACH	97.00
1947 PICKUP 51C-11653 EACH	26.00



**HORN MOTOR WIRING**

1933-35 PASSENGER ,33-34 COM. 46-14436 EACH	11.00
1935-37 PICKUP & COMMERCIAL 50-14436 EACH	12.50
1936-37 PASSENGER 1936-47 PICKUP (11") 68-14436 EACH	7.25

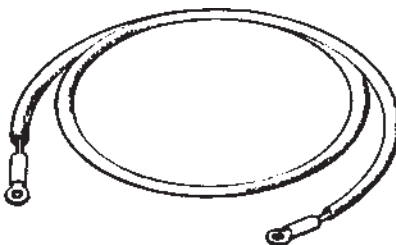

**COIL WIRING  
ORIGINAL IN EVERY DETAIL**

1932-34 PASSENGER & 32-34 P.U. 4 CYL, B-14302 EACH	11.50
1933-34 4 CYL PASSENGER 46-14302 EACH	13.00
1942-47 PASSENGER & PICKUP 27" LONG 21A-14302 EACH	6.25
1947-48 PASSENGER & PICKUP 11 1/2" LONG 7RA-14302 EACH	4.00
1938, CONNECTS COIL TO FUSE BOX, USED WITH 81A-14401 DASH WIRING WHEN USING A LATE MODEL VOLTAGE REGULATOR ON FIREWALL. 81A-14419 EACH	39.00
1941-47 PASSENGER & 6 CYL. PICKUP 22" LONG 2GA-14302 EACH	5.50
1947-48 PASSENGER & 47 6 CYL. PICKUP 7" LONG 7HA-14302 EACH	4.00

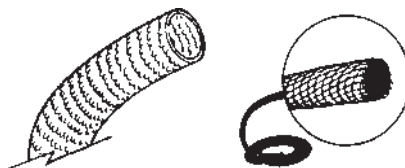

<b>WOVEN LOOM</b> SPECIFY 1/4", 5/16", OR 1/2" I.D. B-14597 PER FOOT (5 FT. MIN)	1.00
--	------

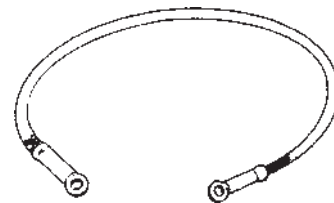

**ENGINE WIRING**

1941-48 PASSENGER, 46-47 PICKUP CONNECTS OIL PRESSURE SENDING UNIT TO 11A-14305-A, & GENERATOR TO VOLTAGE REGULATOR HARNESS. 11A-14322 EACH	6.00
1941-48 V-8, GENERATOR TO VOLTAGE REGULATOR HARNESS 11A-14305-A EACH	33.00
1941-48 6 CYL, GENERATOR TO VOLTAGE REGULATOR HARNESS 1GA-14305 EACH	46.50
1940-48 PASSENGER & PICKUP CONNECTS BOTH TEMP. SENDING UNITS. 51A-14432 EACH	5.50
1941-48 OIL PRESSURE SENDING UNIT- TO COWL WIRE (8 CYL.) 1GA-14322 EACH	17.00
1946 6 CYL, TEMP. SENDING WIRE 5" 1GA-14432 EACH	3.00

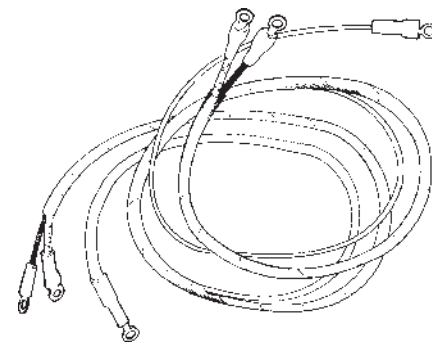

**COWL & PARKING LAMP WIRING**

1928-34 COWL LAMP PIGTAIL B-13412 PAIR	3.50
1932-34 COWL LAMP CROSS OVER WIRE B-14428 EACH	16.00
1947-48 PASSENGER, 42-47 PICKUP PARKING LAMP PIGTAIL 6A-13234 EACH	21.00
1942-48 PASSENGER, PIGTAIL TO SPLICE 0A-14499 (W/TURN SIGNALS) INQUIRE	

# WIRING (CONT'D.)

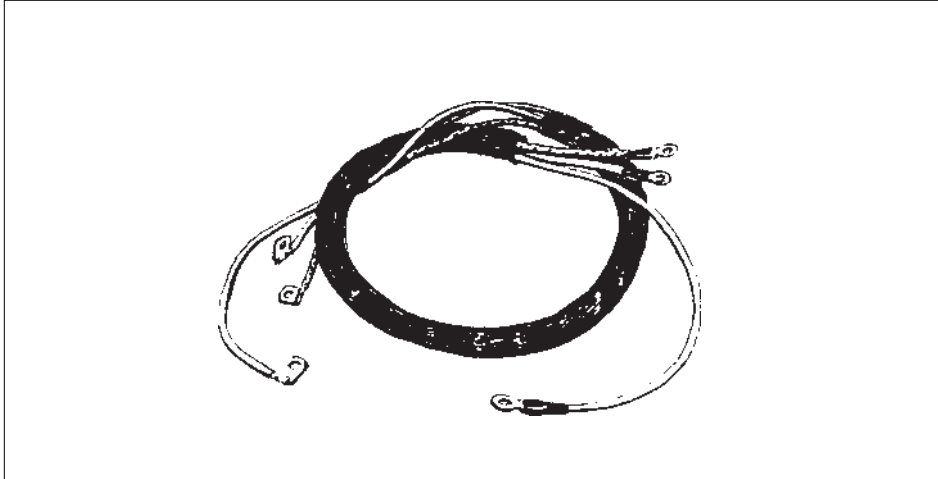

**DASHLIGHT SOCKET WIRING**  
CONNECTS TO DASH WIRING HARNESS

1932-34 PASSENGER & COMMERCIAL 40-13710 EACH	7.00
1935-39 PASSENGER & COMMERCIAL 48-13710 EACH	13.00
1939 MERCURY PASSENGER 99A-13710 EACH	16.00

**DASH WIRING HARNESS**

1932 4 CYL. PASSENGER & PICKUP B-14401 EACH	61.50	1940 STANDARD & DELUXE PASSENGER 01A-14401 EACH	158.00
1932 V-8 PASSENGER & PICKUP 18-14401 EACH	67.75	1941 PASSENGER 11A-14401 EACH	166.70
1933-34 4 CYL. PASSENGER & PICKUP POST AMP. GAUGE 46-14401-A EACH	96.00	1942-47 PASSENGER, IGNITION SWITCH ON COLUMN, USED IN CONJUNCTION WITH 51A-11653-A 21A-14401 EACH	174.00
46-14401-B EACH	86.00		
1933-34 V-8 PASSENGER & PICKUP POST AMP GAUGE 40-14401 EACH	72.00	1947 PASSENGER, IGNITION SWITCH ON DASH, USED IN CONJUNCTION WITH 51A-11653-B 51A-14401-B EACH	260.00
1933-34 V-8 PASSENGER & PICKUP WITH V8 AMP LOOP 40-14401-B EACH	71.50	1940 MERCURY (EARLY) 09A-14401-B EACH	218.00
1935-36 PASSENGER & PICKUP 68-14401 EACH	95.00	1940 MERCURY (LATE)) 09A-14401-C EACH	227.00
1937 PASSENGER & PICKUP 78-14401 EACH	107.50	1942-46 MERCURY, IGNITION ON STEERING COLUMN 59A-14401-A EACH	226.00
1938 PASSENGER & PICKUP 81A-14401 EACH	80.00	1947-48 MERCURY, IGNITION SWITCH ON DASH 59A-14401-B EACH	387.00
1939 STANDARD PASSENGER USING CUTOFF 91A-14401-A EACH	140.50	1940 PICKUP 01C-14401 EACH	157.00
1939 STANDARD PASSENGER USING VOLTAGE REGULATOR 91A-14401-C EACH	137.50	1941-44 PICKUP & COMMERCIAL 11C-14401 EACH	169.00
1939 DELUXE PASSENGER 91A-14401-D EACH	137.50	1941-47 6 CYL. PICKUP 1GC-14401 EACH	236.00
1939 PICKUP, 3 BRUSH GEN. 91C-14401-A EACH	151.00	1945-47 PICKUP 51C-14401-A EACH	179.00
1939 PICKUP, 2 BRUSH GEN. 91C-14401-B EACH	114.00		
1939 MERCURY 99A-14401 EACH	206.00		

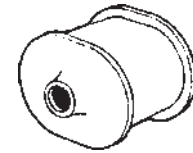

**WIRE LOOM GROMMET**  
FITS FIREWALL  
1935-48  
48-700731 EACH



**HORN BUTTON WIRE**  
GOES FROM STEERING WHEEL  
DOWN COLUMN AND CONNECTS  
TO HEADLIGHT HARNESS.  
1940 PASSENGER  
01A-3671 EACH



**HORN RELAY WIRE**  
1941-47  
11A-13842-D EACH

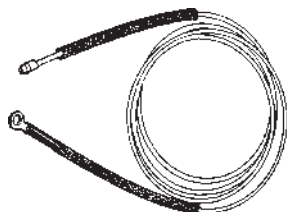

**DOMELIGHT WIRING**

1941-48, ALL CLOSED CARS  
11A-14335-B EACH 7.50

1942-48 STATION WAGON  
11A-14334-C EACH 35.00

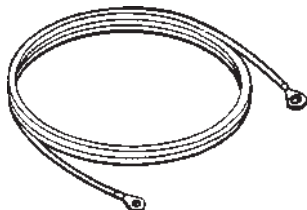

**COLOMBIA OVERDRIVE HARNESS**

1946-48  
CONNECTS CONTROL SWITCH TO  
COLOMBIA SOLENOID.  
11A-14382 EACH 35.00

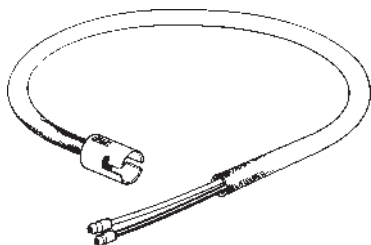

**TAIL LIGHT SOCKET WIRE**

CONNECTS FROM INSIDE HOUSING  
TO MAIN HARNESS. BLACK CONDUIT  
NOT INCLUDED.

1932 PASSENGER, 32-42 PICKUP,  
STATION WAGON & COMMERCIAL  
A-13410 EACH 6.00

1933-48 PASSENGER & SEDAN DELIVERY  
1946-48 PICKUP, STATION WAGON &  
COMMERCIAL  
WIRE ONLY 40-13410 EACH 7.00  
WIRE WITH SOCKET 01C-13410 EACH 8.50



**TAIL LIGHT SOCKET**

CAD PLATED STAMPED STEEL

1932 PASSENGER  
1932-42 PICKUP, WAGON & COMM.  
(IN-LINE NOTCHES)  
A-13410-S EACH 2.00

1933-48 PASSENGER & SEDAN  
DELIVERY, 1946-48 PICKUP, WAGON &  
COMMERCIAL (OFF-SET NOTCHES)  
40-13410-S EACH 2.00



**TAIL LIGHT WIRING HARNESS**

PLUGS INTO MAIN DASH HARNESS OR  
HEADLIGHT HARNESS, DEPENDING ON  
YEAR. IT RUNS ALONG LEFT SIDE OF  
FRAME AND INCLUDES LEADS FOR GAS  
TANK SENDING UNIT, STOP LIGHT  
SWITCH, LEFT TAIL LIGHT AND REAR  
LICENSE LAMP WHEN APPLICABLE.

1935-38 PASSENGER & PICKUP  
81A-14405 EACH 57.00

1939-40 PASSENGER & PICKUP  
91A-14405 EACH 59.00

1941-48 PASSENGER DELUXE &  
SUPER DELUXE (EXCEPT SED. DEL.)  
51A-14405-A EACH 80.00

1941-48 SPECIAL & STATION WGN.  
51A-14405-B EACH 114.00

1939-40 MERCURY  
(EXTRA WIRE FOR TURN SIGNALS)  
99A-14405 EACH 115.00

1941-48 MERCURY  
59A-14405 EACH 145.00

1939-40 TRUCK (EXCEPT C.O.E.)  
91T-14405 EACH 112.50

1941-47 TRUCK (EXCEPT C.O.E.)  
11T-14405 EACH 113.50

1942-47 PICKUP & COMMERCIAL  
21C-14405 EACH 54.50

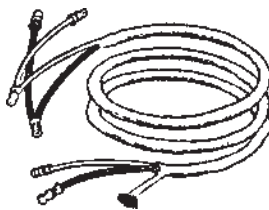

**TAIL LIGHT CROSSOVER  
TO RIGHT TAIL LIGHT**

1932-48  
B-14424 EACH 20.00

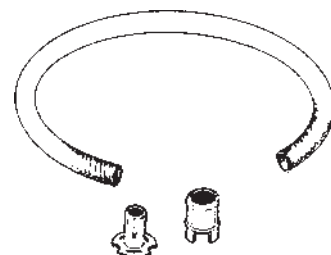

**HEADLIGHT & TAIL LIGHT CONDUIT  
REPAIR KIT**

1937-48 PASSENGER, 40-47 PICKUP  
78-14597-RK KIT FOR 1 LIGHT 20.00

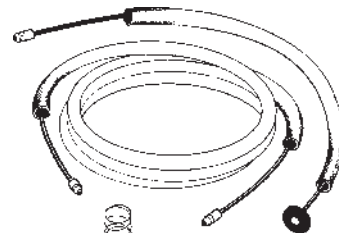

**LICENSE LIGHT WIRE**

1938-48 FOR CARS WITH DECK  
HANDLE & BASE  
81A-13412 EACH 3.50

1938-48 GOES THROUGH TRUNK LID  
AND MAKES CONNECTION WITH  
LICENSE LAMP PIGTAIL 81A-13412  
91A-14415 EACH 11.25



**WIRING HARDWARE**

1932-48 FEMALE CONNECTOR (BLACK)  
B-14487 PACKAGE OF 10 6.00

1932-48 FEMALE CONNECTOR (BROWN)  
81A-14487 LARGE, 1 REQ. EACH 2.50

1942-48 FEMALE CONNECTOR, 4 WAY  
59A-14487 EACH 3.00

1932-48 FRAME WIRING CLIPS  
B-14585-S EACH .50  
B-14585-L EACH (LARGE) .50

1932-48 MALE CONNECTOR, BRASS  
FOR 18 GAUGE WIRE  
B-14486 LOT OF 10 5.00

1932-48 BLACK FLEXIBLE CONDUIT  
SPECIFY: 1/4", 5/16", 1/2". MINIMUM 5 FEET  
B-14597 PER FOOT 1.00

**USE OUR TOLL FREE  
ORDER NUMBER:  
1-800-532-1932**

# COIL & DISTRIBUTOR



### IGNITION COIL

- 1932-34 4 CYLINDER  
B-12000 EACH 25.00  
B-12000-12V EACH 25.00
- 1932-36, 3 SCREW MOUNT  
18-12024 EACH 95.00
- 1937-41, 2 SCREW MOUNT  
(FORD SCRIPT WHEN AVAILABLE)  
78-12024 EACH 95.00
- 1942-48  
1GA-12024 EACH 95.00

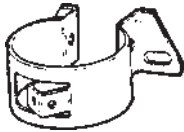

### IGNITION COIL MOUNTING BRACKET

- (FITS B-12000 COIL)
- 1932-34 4 CYLINDER  
A-12000- CB EACH 6.00



### COIL BRUSH & SPRING

- 1932-36 V8  
18-12010-S 5.95
- 1937-41 V-8 (USED ON 78-12024 COIL)  
68-12010-S 5.95

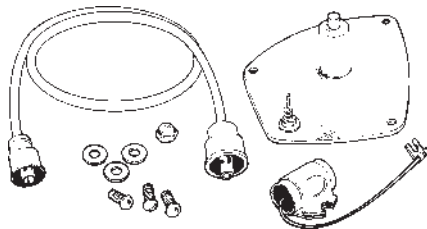

### 1932-41 COIL ADAPTER

ADAPTS NEW STYLE COIL TO  
OLD STYLE DISTRIBUTOR

- 1932-36  
18-12029-CA EACH 52.00
- 1937-41  
78-12029-CA EACH 52.00

## V-8 DISTRIBUTOR PARTS

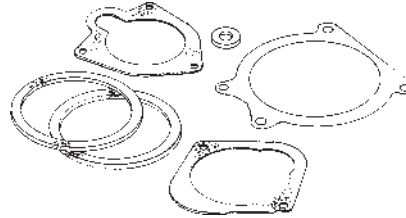

### GASKET SETS

- 1932-41 V-8  
18-12104 SET 8.50
- 1942-48 V-8  
21A-12104 SET 8.50

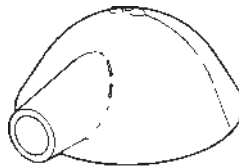

### DISTRIBUTOR TERMINAL PLATE CAP

- 1932-41 V-8  
18-12105 EACH 12.50

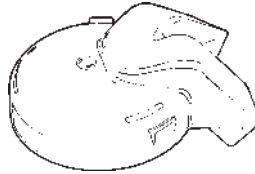

### OUTER DISTRIBUTOR CAP

- 1946-48 V-8  
59A-12105 EACH 25.00



### DISTRIBUTOR CAP - U.S.A.

- 1941-47 6 CYLINDER  
1GA-12106 EACH 30.00

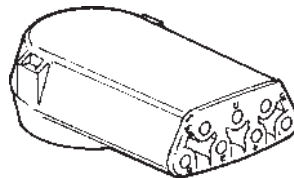

### DISTRIBUTOR CAP - U.S.A.

- 1946-47 6 CYLINDER  
5GA-12106 EACH 52.00

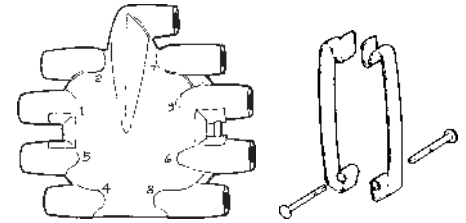

### "CRAB" DISTRIBUTOR CAP - U.S.A.

- 1942 V8  
21A-12106 EACH 20.00

### DISTRIBUTOR CLAMPS & RIVETS

- 1941-46 6 CYL. CRAB & '42-46 8 CYL. CRAB  
21A-12144-S SET 4.25

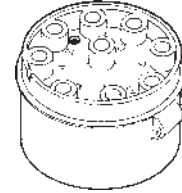

### INNER DISTRIBUTOR CAP - U.S.A.

- 1946-48 V-8  
59A-12106 EACH 39.95

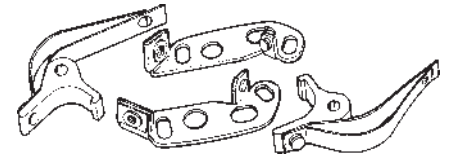

### IGNITION POINT SET

- 1932-35 V-8 (FLAT COPPER STRAP)  
18-12107 SET 21.00

- 1936-48 V-8  
68-12107 SET 28.00

- 1941-47 6 CYLINDER, 4 CYLINDER  
1GA-12107 SET 15.00

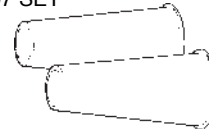

### DISTRIBUTOR RUBBER BOOT

- 1932-41 V-8  
18-12113 SET OF 2 15.00

- 1946-48 V-8  
59A-12113-S SET OF 2 15.00

- 1946-47 6 CYL (G SERIES)  
5GA-12113 EACH 20.00

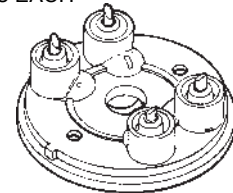

### DISTRIBUTOR TERMINAL PLATE (INNER CAP)

- 1932-36 V-8  
18-12116 EACH 24.50

- 1936-41 V-8  
68-12116 EACH 24.50

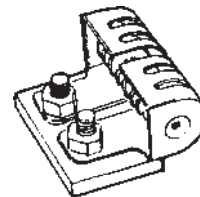
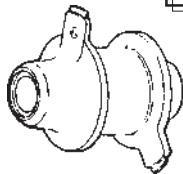

**REBUILT DISTRIBUTORS**  
PROFESSIONALLY REBUILT USING ORIGINAL-TYPE MACHINE. PRE-TIMED

1932-34 4 CYLINDER  
B-12127 EACH EXCHANGE 325.00  
\*CORE CHARGE \$100.00

1932-36 V-8, 3 COIL SCREWS  
40-12127 EACH, EXCHANGE 145.00

1937-41 V-8, 2 COIL SCREWS  
78-12127 EACH, EXCHANGE 145.00

1941-47 6 CYLINDER  
1GA-12127 EACH, EXCHANGE 145.00

1942 V-8  
21A-12127 EACH, EXCHANGE 145.00

1946-48 V-8  
59A-12127 EACH, EXCHANGE 145.00  
**EXCHANGE CORE CHARGE 75.00**



**4 CYLINDER DISTRIBUTOR PARTS**

**DISTRIBUTOR BODY**  
1932-34  
B-12105 EACH 20.00  
HIGH SPEED (WITH WIRES)  
B-12105-HS EACH 27.00

**DISTRIBUTOR CAP**  
1932-34  
B-12115 EACH 5.00

**POINT SET**  
1932-34  
B-12199 SET 25.00

**CONDENSOR**  
1932-34  
B-12300 EACH 15.00

**ROTOR**  
1932-34  
B-12200 EACH 4.50

**SPARK PLUG WIRE CONNECTORS**  
1932-34  
B-12275-S SET OF 4 2.50

**DISTRIBUTOR ROTOR**

1932-36 V-8  
48-12201 EACH 37.50

1937-41 V-8  
68-12201 EACH 37.50

1941-47 6 CYLINDER  
1GA-12200 EACH 7.50

1942-46 V-8  
21A-12200 EACH 10.00

1946-48 V-8  
59A-12200 EACH 15.00

1947-51 6 CYLINDER  
7RA-12200 EACH 3.50

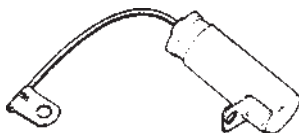

**CONDENSOR**

1932-36 V-8  
18-12300 EACH 15.00

1936 LATE V-8 (FLAT TOP)  
68-12300 EACH 15.00

1938-39 V-8 (SQUARE, HEAVY DUTY)  
81A-12300 EACH 15.00

1937-41 V-8  
78-12300 EACH 15.00

1942-48 V-8  
1GA-12300 EACH 15.00  
1GA-12300-OA6 EACH 15.00

1940-41 4 CYLINDER  
91A-12300 EACH 15.00

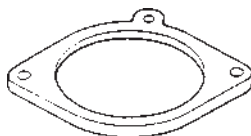

**DISTRIBUTOR ADAPTERS**  
ADAPTS 21A DIST. TO 32-41 BLOCK  
21A-12131 EACH 55.00



**CONDENSOR BOOT**  
FITS THE 1GA-12300  
1GA-12312 EACH 3.00



**DISTRIBUTOR RUBBER PLUG**  
1932-36 V-8  
18-12138 PAIR 5.00

**IGNITION RESISTOR**  
ORIGINAL STYLE, NOT THE CHEAP REPLACEMENT.

1932-48 ALL  
18-12250-O EACH 8.50

**RESISTOR / FUSE TERMINAL BLOCK**  
1933-37 ALL  
40-12250 EACH 20.00

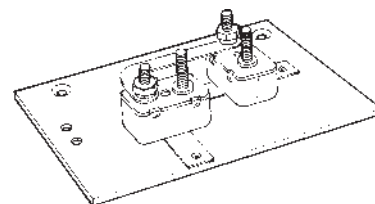

**COMPLETE LIGHT CIRCUIT BREAKER & IGNITION RESISTOR ASSEMBLY**

1933-40 ALL  
01A-12250 EACH 24.50

1941-46 ALL  
11A-12250 EACH 24.50

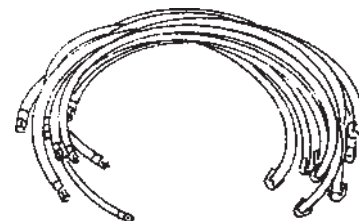

**PLUG WIRES - U.S.A.**  
AUTHENTIC, COLOR CODED

1932-36 V-8, FLAT SPARK PLUG CONNECTORS AS ORIGINAL  
18-12259-A SET 42.75

1932-36 V-8, MODERN CONNECTORS  
18-12259-B SET 42.75

1937-41 V-8, ORIGINAL COLORS  
78-12259 SET 45.00

1946-47 6 CYLINDER  
5GA-12259-B SET 38.00

1947-48 6 CYLINDER  
7HA-12259 SET 43.00

1942-44 V-8, ORIGINAL COLORS  
21A-12259 SET 52.00

1946-48 V-8, ORIGINAL COLORS  
59A-12259 SET 50.00

**ASK ABOUT 1940-41  
4 CYLINDER IGN. PARTS**



# COIL & DISTRIBUTOR (CONT'D.)



### DISTRIBUTOR-TO-MANIFOLD

VACUUM LINE  
1933-36 V-8  
40-12286-B EACH

8.50

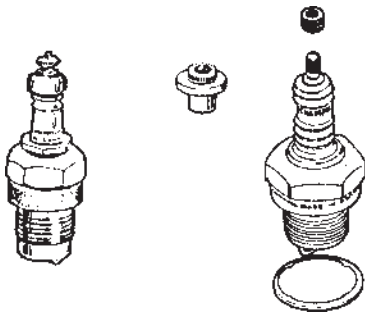

### CHAMPION SPARK PLUGS

1932-34, 4 CYLINDER & 32 V-8  
B-12405-C EACH

9.50

1933-37 V-8, 18 MM  
40-12405 SET OF 8

30.00

1938-48 V-8, 41-47 6 CYL., 14 MM H-10  
7RA-12405 SET OF 8

29.50

### MOTORCRAFT SPARK PLUGS

1932-34, 4 CYLINDER & 32 V-8  
B-12405-M EACH

3.95

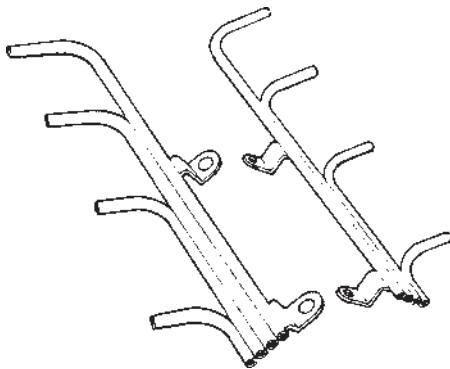

### SPARK PLUG LOOM

POPULAR 50'S STYLE FLAT HEAD  
ENGINE ACCESSORY.  
CHROME PLATED  
CC-12283-L PAIR

75.00

\*\*SPECIFY ENGINE YEAR

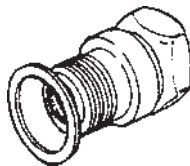

### SPARK PLUG ADAPTERS

1928-34 4 CYL., 1932 V-8  
A-12405-ADP EACH

7.50

1933-37 V-8  
40-12405-ADP EACH

INQUIRE

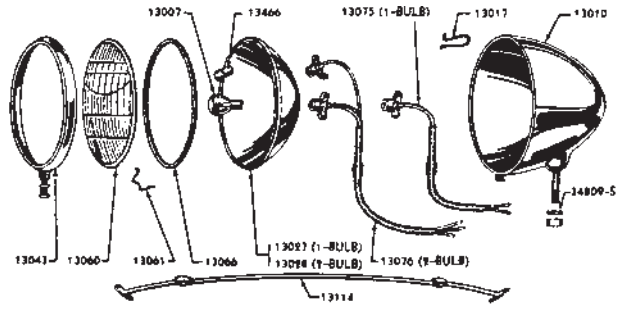

1932 PASSENGER HEADLAMP

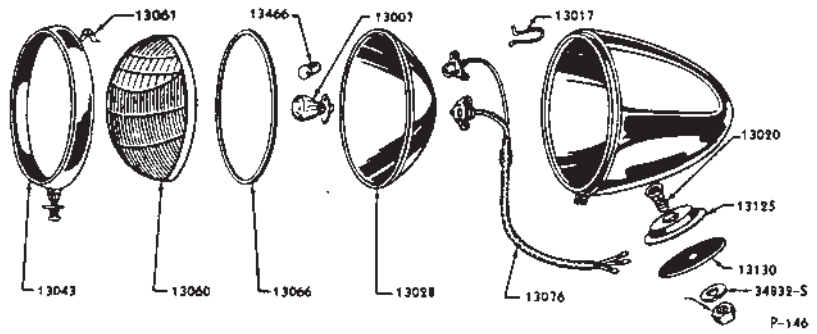

1936 PASSENGER HEADLAMP

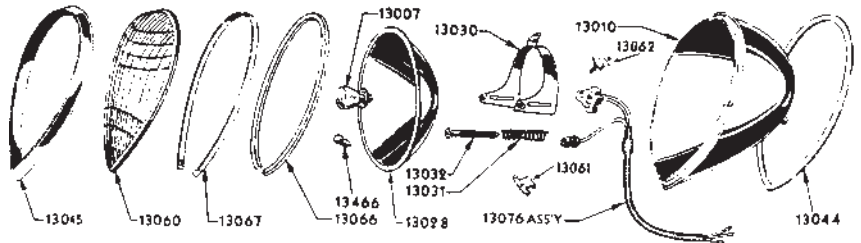

1937-39 PASSENGER & COMMERCIAL HEADLAMP

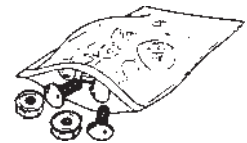

**HEADLAMP SHELL MOUNTING KIT**  
SMOOTH HEAD STAINLESS STEEL BOLTS  
TO APPEAR AS ORIGINAL RIVETS

1932-36 PASSENGER, 32-39 PICKUP  
A-13045-R KIT FOR 2

10.00



**HEADLAMP RIM LOCKING LATCH  
REPAIR KIT**

1932, 1935-36  
A-13044-BS KIT  
1933-34  
A-13044-AS KIT

8.00

8.00

# HEADLAMPS

## HEADLIGHT BUCKET ASSEMBLY

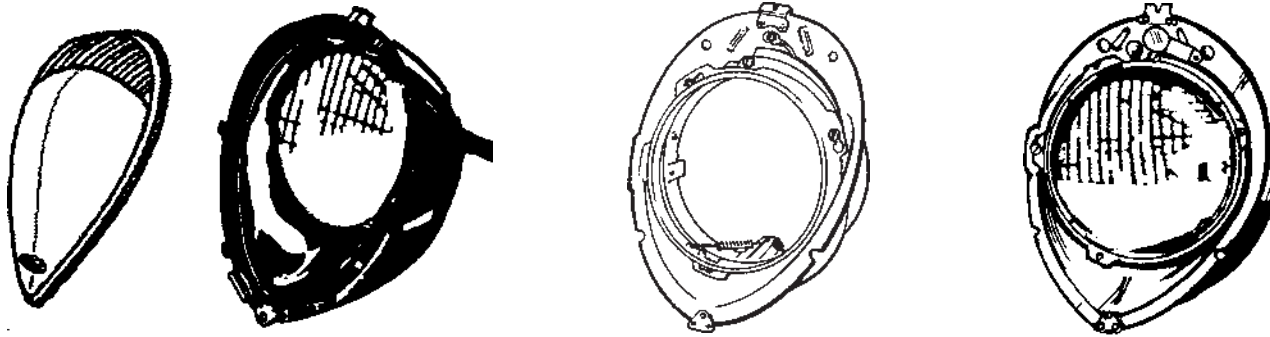

THESE ASSEMBLIES ARE BUILT TO ORIGINAL SPECIFICATIONS: INCLUDING OUTER HOUSING, REFLECTOR RETAINER, SPECIAL ADJUSTING SCREWS AND SPRINGS, BRACKETS, LENS AND HEADLIGHT RIM MOUNTING, BLACK WIRE FLEX CONDUIT MOUNTED TO BUCKET WITH COLLARS, GASKET AND RETAINER BAIL FOR HEADLIGHT LENS, BUCKET-TO-FENDER GASKET, AND BUCKET-TO-FENDER MOUNTING HARDWARE.

**1937-39 STANDARD  
FLAT HALOGEN CONVERSION KIT**  
DOES NOT INCLUDE CLEAR LENS  
78-13030-QK12 KIT FOR 2, 12V ONLY 150.00  
78-13030-QK12TS W/ TURN SIGNALS 175.00

**1937-38 DELUXE & STANDARD  
1939 STANDARD**  
78-13026 PAIR STOCK ASSEMBLIES 225.00

**1940 PASSENGER, 40-41 PICKUP**  
01A-13026 PAIR STOCK ASSEMBLIES 225.00

QUARTZ HALOGEN/W TURN SIGNAL  
SPECIAL CLEAR LENSE INCLUDED  
78-13026-QPR PAIR 12V ONLY 360.00

01A-13026-QPR PAIR 12V ONLY 350.00  
QUARTZ HALOGEN/W TURN SIGNAL

SPECIAL CLEAR LENSE  
78-13060-CL EACH 30.00

**41-48 PASSENGER**  
21A-13026 EACH INQUIRE

**1939 DELUXE**  
91A-13026 PAIR STOCK ASSM 225.00

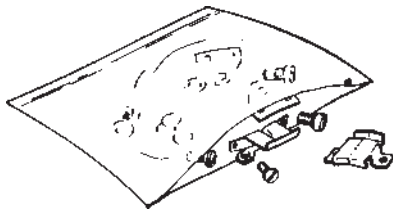

**HEADLIGHT BUCKET, LENS & RIM  
MOUNTING HARDWARE KIT**

**PLEASE CALL WITH ANY QUESTIONS  
CONCERNING HEADLAMP BUCKETS**

**HEADLIGHT BUCKET MOUNTING KIT**  
1937-40 PASSENGER, 40-41 PICKUP  
01A-13026-K KIT FOR 1 BUCKET 5.00

INCLUDED IN THE ABOVE ASSEMBLIES

1937-38 DELUXE & STANDARD  
78-13061-K KIT FOR 1 HEADLIGHT 25.00  
1939 DELUXE  
91A-13061-K KIT FOR 1 HEADLIGHT 25.00

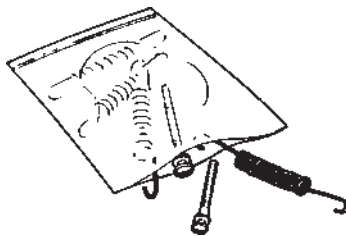

**SEALED BEAM RETAINER HARDWARE KIT**  
1940-48  
01A-13018-K KIT FOR 2 HEADLIGHTS 5.00

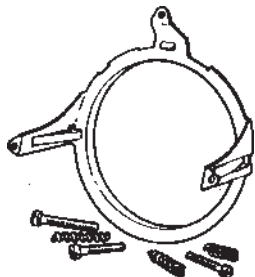

**DELUXE & STANDARD HEADLIGHT  
REFLECTOR RETAINER**

**HEADLAMP REFLECTOR AIMING KIT**  
(6 SCREWS & 6 SPRINGS)  
1937-39 PASSENGER  
78-13032-HK KIT FOR 2 BUCKETS 20.00

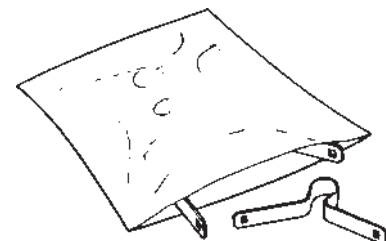

INCLUDED IN ABOVE ASSEMBLIES

1937-38 DELUXE & STANDARD  
78-13030 KIT FOR 1 HEADLIGHT 40.00

**SEALED BEAM ADJUSTING  
HARDWARE KIT**  
1940 PASSENGER, 40-41 PICKUP  
01A-13032-HK KIT FOR 2 BUCKETS 20.00

**HEADLIGHT REFLECTOR  
MOUNTING CLIP SET**  
1935-36 PASSENGER, 35-39 PICKUP  
48-13031 SET FOR 2 HEADLIGHT 12.00

1939 DELUXE  
91A-13030 KIT FOR 1 HEADLIGHT 40.00

# HEADLAMPS

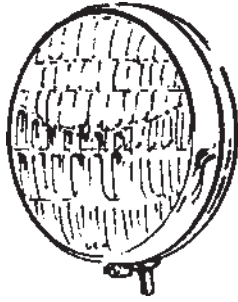

### 1932 HEADLAMPS

POLISHED STAINLESS STEEL  
COMPLETE ASSEMBLY

SINGLE BULB (USE WITH COWL LIGHTS)

6 VOLT  
B-13000-1-6V PAIR 325.00

12 VOLT  
B-13000-1-12V PAIR 325.00

2 BULB (USE WITHOUT COWL LIGHTS)

6 VOLT  
B-13000-2-6V PAIR 325.00

12 VOLT  
B-13000-2-12V PAIR 325.00

55W/60W QUARTZ HALOGEN BULB  
B-13000-Q-12V PAIR 375.00

### 1933-34 HEADLAMPS

SINGLE BULB (USE WITH COWL LIGHTS)

6 VOLT  
40-13000-1-6V PAIR 325.00

12 VOLT  
40-13000-1-12V PAIR 325.00

2 BULB (USE WITHOUT COWL LIGHTS)

6 VOLT  
40-13000-2-6V PAIR 325.00

12 VOLT  
40-13000-2-12V PAIR 325.00

55W/60W QUARTZ HALOGEN BULB  
40-13000-Q PAIR 375.00

6 VOLT QUARTZ AVAILABLE ON SPECIAL  
ORDER. YOU MUST USE AN ALTERNATOR  
TO KEEP BATTERY CHARGED.

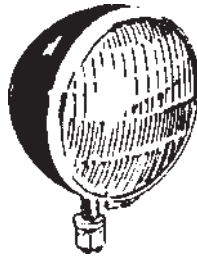

### COMMERCIAL HEADLAMPS

EXACT DUPLICATES OF ORIGINAL

1933-34 PICKUP (2 BULB)  
6 VOLT  
46-13000-A PAIR 325.00

12 VOLT WITH 55W/60W HALOGEN  
46-13000-QH PAIR 350.00  
**6 VOLT HALOGEN ALSO AVAILABLE**

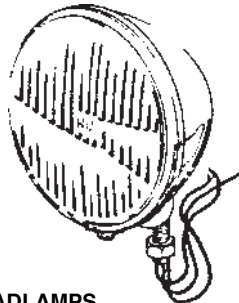

### DIETZ HEADLAMPS

SPECIFY CHROMED OR PAINTED  
7" DIA., 12 VOLT WITH SEAL BEAMS

D-13000-BP (PRIMERED) PAIR 70.00  
D-13000-BC (CHROMED) PAIR 70.00

### KING BEE TYPE HEADLAMPS

SPECIFY CHROMED OR PAINTED

12 VOLT QUARTZ HALOGEN  
KB-13000-QP (PRIMERED) PAIR 150.00  
KB-13000-QC (CHROMED) PAIR 150.00  
KB-13000-QSS (STAINLESS) PAIR 175.00



### LAMP SHELL INNER RING

1932 PASSENGER & COMMERCIAL  
B-13001 EACH 12.00

1933-34 PASSENGER & COMMERCIAL  
40-13001 EACH 12.00

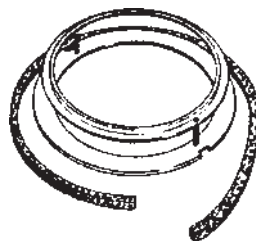

### SEAL BEAM ADAPTER KIT

1932 ALL  
B-13002-SB SET 45.00  
1933-34 ALL  
40-13002-SB SET 45.00  
1935-36 ALL, 35-39 COMM.  
48-13002-SB SET 45.00

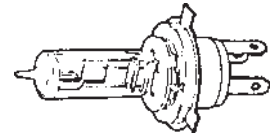

### QUARTZ HALOGEN BULBS

55/60 CANDLE POWER  
6 VOLT  
B-13007-Q6 EACH 18.00  
12 VOLT  
B-13007-Q12 EACH 10.50

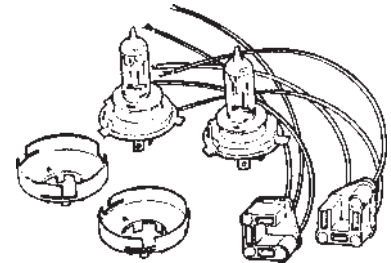

### HALOGEN ADAPTERS

1932-39 INCLUDES BULBS  
B-13026-QH6 6 VOLT KIT FOR 2 45.00  
B-13026-QH12 12 VOLT KIT FOR 2 45.00



### HEADLAMP BULB

1932-34, 32-50 CP 6 VOLT  
B-13007-B EACH 3.00  
1935-39, 32-50 CP 6 VOLT  
48-13007 EACH 3.00  
1932-34, 32-50 CP 12 VOLT  
B-13007-12V EACH 3.00  
1935-39, 32-50 CP 12 VOLT  
48-13007-12V EACH 3.00

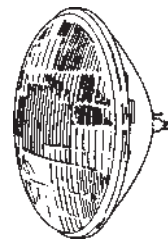

### SEALED BEAM HEADLIGHT

1940-48 6 VOLT  
01A-13007-6V EACH 20.00  
1940-48 12 VOLT  
01A-13007-12V EACH 15.00



### HEADLAMP DOOR LATCH SPRING

1932-36 PASSENGER, 35-39 COMM.  
B-13017 EACH 2.50

**USE OUR TOLL FREE NUMBER**  
**1-800-532-1932**  
**OR OUR FAX NUMBER**  
**408-866-1934**  
**FOR PLACING YOUR ORDER!**

**FOR INFORMATION PLEASE**  
**CALL**  
**408-378-1935**

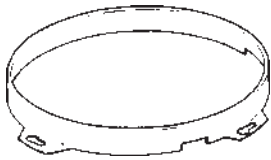

**HEADLAMP INNER RING**  
1940-48 PASSENGER, 40-47 COMM. & TRUCKS  
01A-13018 PAIR 40.00

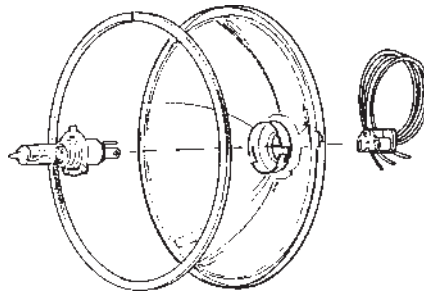

**1932-39 HALOGEN REFLECTOR KIT**  
INCLUDES MACHINED ORIGINAL TYPE REFLECTOR WITH WELDED BULB RETAINERS, BULBS, WIRING SOCKETS, GASKETS.  
1932  
B-13027-QK KIT FOR 2 135.00  
1933-34  
40-13027-QK KIT FOR 2 135.00  
1935-36  
48-13027-QK KIT FOR 2 135.00  
1937-39  
78-13027-QK KIT FOR 2 135.00  
SPECIFY 6 OR 12 VOLT

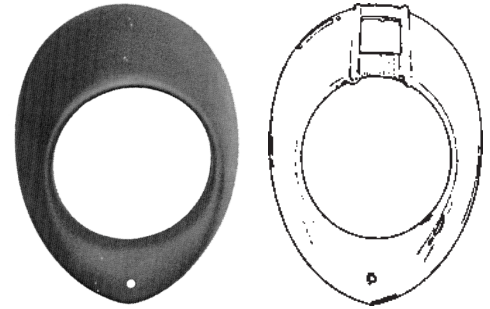

**CHROME & PLAIN HEADLAMP DOORS**  
AAA QUALITY  
1940 DELUXE, 40 MERCURY  
40-41 COMM. (CHROME PLATED)  
01A-13045-B PAIR 150.00  
1940 STD. & 40-41 PICKUP  
01A-13045-A PAIR 150.00  
1940 SMOOTHY  
01A-13045-AN PAIR 98.50

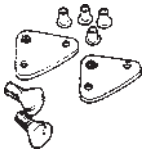

**HEADLAMP BUCKET LOWER TAB KIT**  
1937-39 PASSENGER  
78-13026-R FOR TWO BUCKETS 8.00

**TURN SIGNAL RETROFIT KIT**  
ADDS TURN SIGNALS TO ABOVE KITS  
B-13206-TS12 KIT 27.50

**HEADLAMP RIM SCREWS**  
1940 PASSENGER, 40-41 COMM.  
01A-13045-MB PAIR 2.00



**HEADLAMP RIM REPAIR BRACKET**  
1940 PASSENGER, 40-41 COMM.  
01A-13026-R SET FOR 2 8.00

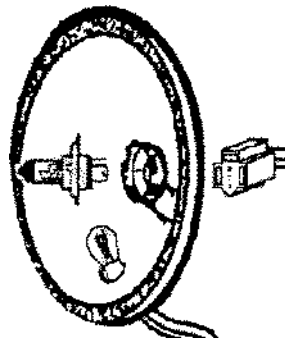
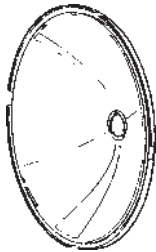

**HALOGEN REFLECTOR KITS WITH TURN SIGNALS**  
1932  
B-13027-QK12TS KIT FOR 2 135.00  
1933-34  
40-13027-QK12TS KIT FOR 2 135.00  
1935-36  
48-13027-QK12TS KIT FOR 2 135.00  
1937-39  
78-13027-QK12TS KIT FOR 2 135.00

**HEADLAMP DOOR OUTER TRIM RING**  
1932 STAINLESS STEEL  
B-13045 EACH 35.00

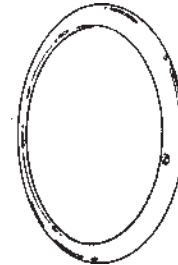

**NEW HEADLAMP REFLECTORS**  
DIE STAMPED BRASS & SPECIALLY PLATED FOR HIGHEST REFLECTIVITY.

1932 ONE BULB  
B-13027-1 EACH 45.00

1932 2 BULB  
B-13028-2 EACH 45.00

1933-34 ONE BULB  
40-13027-1 EACH 45.00

1933-34 2 BULB  
40-13028-2 EACH 45.00

1935-36 PASSENGER  
1935-39 PICKUP  
48-13028 EACH 45.00

1937-39  
78-13028 EACH 45.00

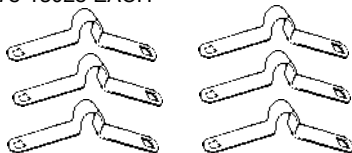

**HEADLAMP REFLECTOR CLIPS**  
1935-36 PASSENGER, 35-39 COMM.  
48-13031 SET OF 6 12.00

**HEADLAMP TO FENDER GASKET**  
1937-39 STANDARD  
78-13044 PAIR 10.00

1939 DELUXE  
91A-13044 PAIR 10.00

1940 PASSENGER, 40-41 PICKUP  
01A-13044 PAIR 10.00

1941-48 PASSENGER, 42-47 COMM  
11A-13044 PAIR 10.00

1933-34 STAINLESS STEEL  
40-13045 EACH 35.00

1935 PASS, 35-39 COMM STAINLESS STEEL  
48-13045 PAIR 75.00

1936 CAR STAINLESS STEEL  
68-13045 PAIR 95.00

1937-38 CAR 1939 STD STAINLESS STEEL  
78-13045 EACH 30.00

1939 DELUXE STAINLESS STEEL  
91A-13045 EACH 30.00

1941 TRUCK, 41-47 COE STAINLESS  
11T-13043-A STAINLESS EACH INQUIRE

1941 PASSENGER 2-GROOVES  
11A-13045 CHROME PAIR 45.00  
11A-13045-SS STAINLESS PAIR 65.00

1942-47 PASS & TRUCK 3-GROOVES  
21T-13045 CHROME PAIR 45.00  
21T-13045-SS STAINLESS PAIR 65.00

1946 1-GROOVE  
51A-13045-SS STAINLESS PAIR 65.00

1947-48 PASSENGER, SMOOTH  
6A-13045 CHROME PAIR 45.00  
6A-13045-SS STAINLESS PAIR 65.00

# HEADLAMPS

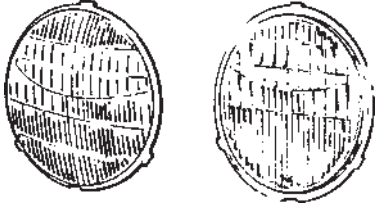

**HEADLAMP LENS, GLASS**

FORD SCRIPT GLASS LENS, U.S.A.

AAA QUALITY

1932 ALL

B-13060 EACH 35.00

1933-34 ALL

40-13060 EACH 35.00

1935 PASSENGER, 35-39 PICKUP

48-13060 EACH 35.00

1936 PASSENGER

68-13060 EACH 35.00

1937-38 PASSENGER, 39 STD.

78-13060 EACH 35.00

1939 DELUXE PASSENGER

91A-13060 EACH 35.00



**HEADLAMP LENS RETAINER CLIPS**

1932 ALL

B-13061-S SET OF 6 5.00

1933-34 PASSENGER & PICKUP

40-13061-S SET OF 6 5.00

1935-36 PASSENGER, 35-39 COMM.

48-13061-S SET OF 6 8.50

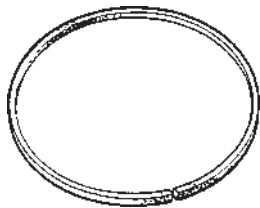

**HEADLAMP LENS CORK GASKET**

1932-36 PASSENGER, 32-39 PICKUP

B-13066 PAIR 5.00

1937-39 PASSENGER

78-13066 PAIR 5.00



**HEADLAMP LENS GASKET RETAINER**

**BAIL - BRASS**

1937-39

78-13067 PAIR 15.00



**HEADLAMP BUCKET WIRING GROMMET**

1942-48 PASSENGER

51A-13077 PAIR 4.50



**HEADLAMP BAR**

1932 PASSENGER, 32 PICKUP

ORIGINAL STYLE WITH STAINLESS

CENTER & PAINTED ENDS

18-13114-A EACH (RESTORED) 210.00

1932 WITH 4" DROP

ALL POLISHED STAINLESS STEEL

18-13114-B EACH 200.00

1933-34 PICK-UP DROPPED HEADLIGHT

BAR (EXCHANGE)

46-13114 EACH 325.00\*\*

STAINLESS CENTER

46-13114-SS EACH 325.00\*\*

\*\*WE REQUIRE YOUR ORIGINAL HEADLAMP BAR OR THERE WILL BE A \$125.00 CORE CHARGE ADDED TO THE TOTAL PRICE

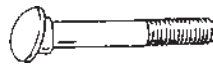

**HEADLAMP BAR-TO-FENDER BOLT**

1932 FORGED STEEL (BLACK)

B-13119 EACH 10.00

1932 POLISHED STAINLESS

B-13119-SS EACH 15.00

1933-34 HOLLOW FOR HORN WIRE (BLACK)

40-13119-BK EACH 5.00

1933-34 HOLLOW FOR HORN WIRE POLISHED STAINLESS

40-13119-SS EACH 8.00

1933-34 SOLID, BLACK

40-13119-NHBR EACH 5.00

1933-34 SOLID, STAINLESS STEEL

40-13119-NHSS EACH 8.00

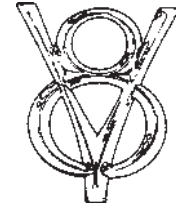

**HEADLAMP BAR EMBLEM, CHROME**

1932 V-8

18-13122 EACH 35.00

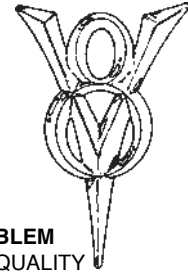

**V-8 GRILLE EMBLEM**

CHROME, AAA QUALITY

1933 PASSENGER, 33-34 PICKUP

40-8217-A EACH 35.00

1934 PASSENGER

2-PIECE WITH BLUE BACKGROUND 40-8221 EACH 40.00

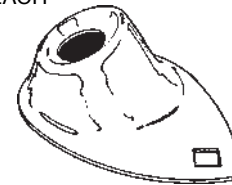

**HEADLAMP STANDS**

1933-34 PASSENGER

40-13125-A INQUIRE

CHOPPED

BLACK

40-13125-SB PAIR 50.00

CHOPPED, POLISHED STAINLESS

40-13125-SS PAIR 60.00

1935 PASSENGER

48-13125-A INQUIRE

1936 PASSENGER

68-13125-A INQUIRE



**HEADLAMP PADS**

1932 PASSENGER, 32-34 PICKUP

B-13130 PAIR 10.00

1933-34 PASSENGER, 35-37 PICKUP

40-13130 PAIR 10.00

1935 PASSENGER

48-13130 PAIR 10.00

1936 PASSENGER

68-13130 PAIR 10.00

1938-39 PICKUP

81C-13130 PAIR 20.00

# PARKING LAMPS



**PARKING LAMP ASSEMBLY**  
AAA QUALITY  
1941 PASSENGER  
11A-13200 EACH 45.00

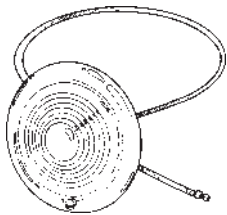

**PARKING LAMP ASSEMBLY**  
AAA QUALITY  
1947-48 PASSENGER, 42-47 PICKUP  
6A-13200 EACH 45.00  
DUAL WIRE FOR TURN SIGNAL  
6A-13200-T EACH 50.00

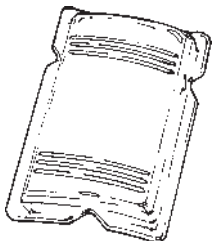

**PARKING LAMP LENS, GLASS**

1940 PASSENGER & PICKUP  
01A-13082 EACH 15.00  
**\*\*NEW LED LENS LED'S BUILT RIGHT INTO THE LENS**  
HR-13082 EACH 22.50

1941 PICKUP  
11C-13082-G EACH 10.00

1941 PASSENGER  
11A-13082-G EACH 12.00  
11 A-13082-GAMB AMBER LENS 12.00

1947-48 PASSENGER, 42-47 COMM.  
6A-13082 EACH 10.00  
6A-13082-AMB AMBER LENS 10.00

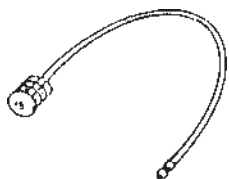

**PARKING LAMP WIRE W/ SOCKET**  
1947-48 PASSENGER, 42-47 PICKUP  
6A-13234 EACH 21.00  
WITH TURN SIGNALS  
6A-13234-B EACH 21.00



**PARKING LAMP LENS BEZELS**  
1940 STANDARD, 40-41 PICKUP  
1941 SEDAN DELIVERY  
01A-13084 PAIR 60.00

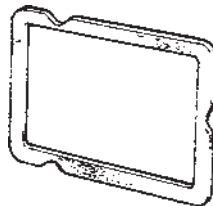

**PARKING LENS GASKET**  
1940 PASSENGER, 40-41 COMM.  
01A-13085 PAIR 5.00

1941 PASSENGER  
11A-13211 PAIR 5.00

1942-46 PASSENGER  
21A-13211 PAIR 6.00

1947-48 PASSENGER, 42-47 COMM.  
6A-13211 PAIR 5.00

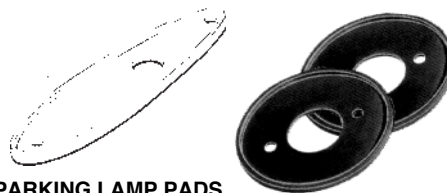

**PARKING LAMP PADS**  
1941 PASSENGER (RUBBER)  
11A-13217-S PAIR 15.00

1942-47 PASSENGER & PICKUP  
6A-13200-RP PAIR 8.00

1947-48 PASSENGER, 42-47 COMM.  
CORK  
21C-13217 PAIR 8.00

1947-48 PASSENGER, 42-47 COMM.  
RUBBER  
6A-13200-RP PAIR 8.00

1942-48 MERCURY (RUBBER)  
29A-13217/8 PAIR INQUIRE



**PARKING LAMP BOOT**  
1942-48 PASSENGER, 42-47 COMM.  
6A-13225 PAIR 17.50



**PARKING LAMP LENS CLIPS**  
1940 PASSENGER, 40-41 PICKUP  
350786-S7 SET OF 6 3.00

# COWL LAMPS

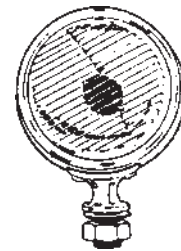

**COWL LAMPS & ARMS**  
AAA QUALITY  
1932 PASSENGER  
B-13302 PAIR 100.00  
WITH TURN SIGNALS  
B-13302-TS PAIR 100.00

**COWL LAMPS & ARMS**  
AAA QUALITY  
1933-34 PASSENGER  
40-13302 PAIR 100.00  
WITH TURN SIGNALS  
40-13302-TS PAIR 100.00

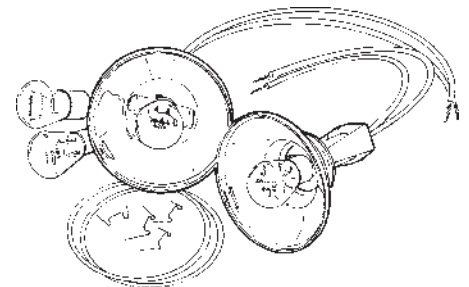

**TURN SIGNAL ADAPTER KITS**  
ADAPT COWL LAMPS OR OIL  
SIDE LAMPS TO TURN SIGNALS.

1932 PASSENGER  
B-13303-TS KIT (PAIR) 45.00

1933-34 PASSENGER  
40-13303-TS KIT (PAIR) 45.00

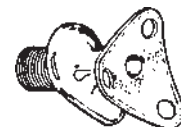

**COWL LAMP ARMS, CHROME**  
AAA QUALITY

1932  
B-13322 PAIR 55.00

1933-34  
40-13322 PAIR 55.00

# COWL LAMPS TAIL LAMPS

(CONT'D.)



**COWL LAMP LENS, GLASS**

1932  
B-13308 EACH 8.00

1933-34  
40-13308 EACH 10.00

**LENS CORK**

1932 B-13309 PAIR 2.00

1933-34 40-13309 PAIR 2.00

**LENS CLIPS 1932-34**

A-13316-S 6 PIECES 2.00



**COWL LAMP MOUNTING PADS**

1932, (EXCEPT 3-WINDOW)  
B-13324-A PAIR 8.00

1932 3-WINDOW  
B-13324-B PAIR 8.00

1933-34  
40-13324 PAIR 8.00

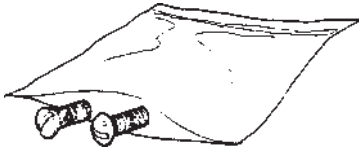

**COWL LAMP MOUNTING SCREWS**

1932  
1127 SET OF 6 2.00

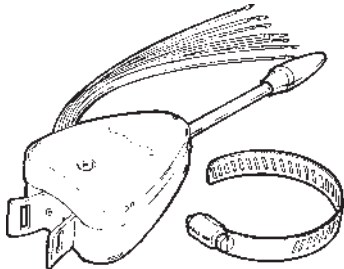

**ACCESSORY TURN SIGNAL SWITCH ASSEMBLY**

CLAMPS TO STEERING COLUMN.  
ORIGINAL STYLE EARLY ACCESSORY  
6V OR 12V DEPENDING ON BULB

1932-48 ALL, CHROME  
A-13340-TS EACH 19.95

1932-48 ALL HEAVY DUTY  
A-13340-HDTS EACH 29.95

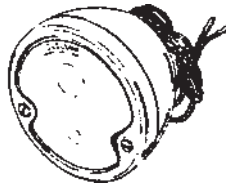

**TAIL LAMP ASSEMBLY**

1932 PASSENGER  
RIGHT HAND, POLISHED STAINLESS  
B-13407 EACH 30.00

**\*\*NEW LED ASSEMBLY**  
B-13407-LED EACH 50.00

1932-42 COMMERCIAL  
RIGHT HAND, BLACK BUCKET  
B-13407-B EACH 30.00

1932 PASSENGER  
LEFT HAND, POLISHED STAINLESS  
B-13408 EACH 30.00

**\*\*NEW LED ASSEMBLY**  
B-13408-LED EACH 60.00

1932-42 COMMERCIAL  
LEFT HAND, BLACK BUCKET  
B-13408-B EACH 30.00



**1933-34 PASSENGER**  
**1933-34 SEDAN DELIVERY**  
RIGHT HAND, POLISHED STAINLESS  
40-13407 EACH 30.00

**\*\*NEW LED ASSEMBLY**  
40-13407-LED EACH 50.00

LEFT HAND, POLISHED STAINLESS  
40-13408 EACH 30.00

**\*\*NEW LED ASSEMBLY**  
40-13408-LED EACH 60.00

WILL ALSO FIT 1935-36

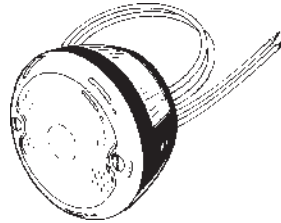

**1935-36 PASSENGER (ORIGINAL)**  
**1935-48 SEDAN DELIVERY**  
RIGHT HAND, BLACK BUCKET  
48-13407 EACH 30.00

**\*\*NEW LED ASSEMBLY**  
48-13407-LED EACH 50.00

LEFT HAND, BLACK BUCKET  
48-13408 EACH 30.00

**\*NEW LED ASSEMBLY**  
48-13408-LED EACH 60.00



**1940-47 PICKUP, 46-48 STATION WAGON AND COMMERCIAL**

RIGHT HAND, BLACK BUCKET  
01C-13407 EACH 30.00

LEFT HAND, BLACK BUCKET  
01C-13408 EACH 30.00

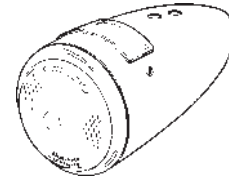

**1937 PASSENGER**

RIGHT HAND, BLACK BUCKET  
78-13402 EACH 45.00

**\*\*NEW LED ASSEMBLY**  
78-13402-LED EACH 55.00

LEFT HAND, BLACK BUCKET  
78-13403 EACH 45.00

**\*\*NEW LED ASSEMBLY**  
78-13403-LED EACH 65.00

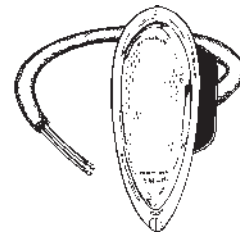

**1938-39, STAINLESS RIM, GLASS LENS**  
FITS EITHER SIDE  
81A-13405 EACH 30.00

**\*\*NEW LED ASSEMBLY**  
81A-13405-LED EACH 50.00

**\*\*FLUSH MOUNT**  
81A-13405-LED F EACH 50.00

**ALL TAIL LAMPS CAN BE FURNISHED WITH BLUE DOTS! ADD \$8.00**

SEE PAGE 213 FOR PONTIAC TAIL LAMPS

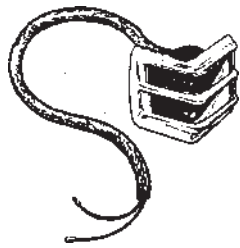

**1940, STAINLESS RIM, GLASS LENS**  
 FITS EITHER SIDE  
 01A-13405 EACH 30.00  
**\*\*NEW LED ASSEMBLY**  
 01A-13405-LED EACH 60.00

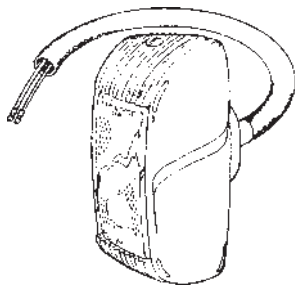

**1941 PASSENGER, 46-48 SPORTSMAN**  
 RIGHT SIDE, CHROME  
 11A-13404 EACH 75.00  
 LEFT SIDE, CHROME  
 11A-13405 EACH 75.00

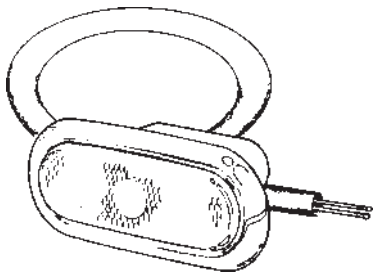

**1942-48 PASSENGER**  
 FITS EITHER SIDE  
 21A-13408 EACH 30.00  
**\*\*NEW LED ASSEMBLY**  
 21A-13408-LED EACH 50.00  
**\*\*FLUSH MOUNT**  
 21A-13408-LEDF EACH 50.00

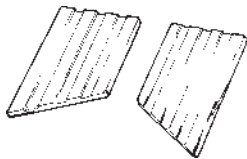

**TAIL LAMP HOUSING TRIM**  
 1942-48 PASSENGER  
 21A-13476-AS PAIR 35.00

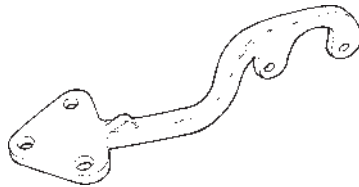

**TAIL LAMP BRACKET**  
 CAST STEEL AS ORIGINAL  
 1932-37 COMMERCIAL  
 B-13470-B EACH 15.00



**TAIL LAMP BRACKET**  
 1932 PASSENGER  
**PAINTED BLACK**  
 RIGHT HAND  
 B-13470 EACH 40.00  
 LEFT HAND  
 B-13471 EACH 40.00

**CHROME PLATED**  
 RIGHT HAND  
 B-13470-C EACH 55.00  
 LEFT HAND  
 B-13471-C EACH 55.00

**COMING SOON! 1940 SEDAN DELIVERY TAIL LAMP BRACKETS. OTHER ORIGINAL TAIL LAMP BRACKETS AVAILABLE INCLUDING WOODY & COMMERCIAL**



**TAIL LAMP BRACKETS**  
 1933-34 PASSENGER  
**PAINTED BLACK**  
 RIGHT HAND, USED WITH RUMBLE SEAT STEP PAD  
 40-13470 EACH 40.00

LEFT HAND, ALSO FITS R.H. WITH NO RUMBLE SEAT  
 40-13471 EACH 40.00

**CHROME PLATED**  
 RIGHT HAND, USED WITH RUMBLE SEAT STEP PAD  
 40-13470-C EACH 55.00

LEFT HAND, ALSO FITS R.H. WITH NO RUMBLE SEAT  
 40-13471-C EACH 55.00

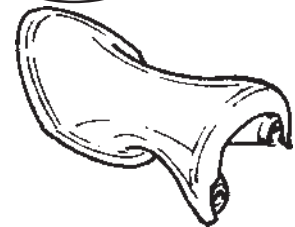

**"SHORTY" TAIL LAMP BRACKETS**  
 1933-34 PASSENGER  
 FITS RIGHT OR LEFT  
 40-13471-CHP EACH 55.00

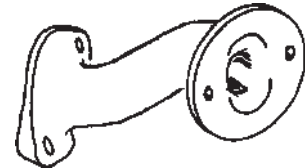

**1935-39 SEDAN DELIVERY TAIL LAMP BRACKET - CAST ALUM.**  
 RIGHT HAND  
 48-13459-RH EACH 85.00???  
 LEFT HAND  
 48-13459-LH EACH 85.00???



**1936 TAIL LAMP BRACKET (RIGHT SIDE)**  
**\*\*ORIGINAL ONLY AT THIS TIME\*\***  
 RIGHT HAND, ALL BODIES, NO RUMBLE SEAT  
 68-13470-A EACH INQUIRE

RIGHT HAND, COUPE, ROADSTER AND CABRIOLET WITH RUMBLE STEP  
 68-13470-B INQUIRE

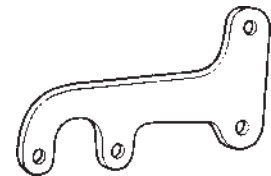

**1935-52 PICKUP TAIL LAMP BRACKETS**  
 1935-36 STAMPED STEEL, BLACK  
 50-13470 EACH 19.25

1937 RIGHT HAND  
 77-13470 EACH INQUIRE

1937 LEFT HAND  
 77-13471 EACH INQUIRE

1938-41 WITHOUT REAR BUMPER  
 91C-13471 EACH 20.00

1938-41 STAINLESS STEEL  
 81C-13471-SS 20.00

WITH REAR BUMPER  
 1942-52 RIGHT HAND  
 81Y-13470 EACH 20.00

1942-52 LEFT HAND  
 81Y-13471 EACH 20.00



# TAIL LAMP

(CONT'D.)

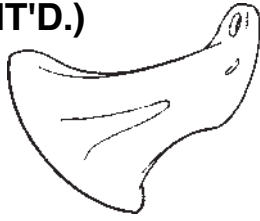

**1937 TAIL LAMP BRACKETS**

RIGHT HAND  
78-13470 EACH 40.00  
LEFT HAND  
78-13471 EACH 40.00



**TAIL LAMP WIRE SHIELD**

1932-47 PICKUP, COMM. & STATION WAGON  
RIGHT OR LEFT HAND, BLACK  
B-13467 EACH 15.00  
POLISHED STAINLESS STEEL  
B-13467-SS EACH 25.00



**TAIL LAMP BRACKET-TO-REAR FENDER SUPPORTS**

1935 PASSENGER  
RIGHT HAND  
48-16360 EACH 30.00  
LEFT HAND  
48-16361 EACH 30.00  
1936 PASSENGER  
RIGHT HAND  
68-16360 EACH 30.00  
LEFT HAND  
68-16361 EACH 30.00

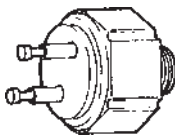

**STOPLIGHT SWITCH**

1939-48 ALL  
11A-13480 EACH 7.50

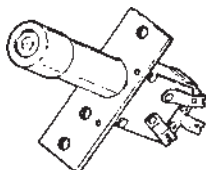

**DIMMER SWITCH**

1938-48 ALL  
81A-13532 EACH 21.00

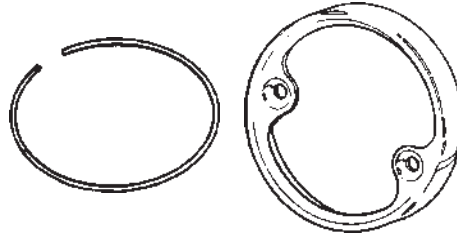

**TAIL LAMP RIM**

1932, POLISHED STAINLESS  
B-13448 EACH 7.00  
1933-36, POLISHED STAINLESS  
40-13448 EACH 7.00  
1937  
78-13448 EACH 8.00  
1938-39, POLISHED STAINLESS  
81A-13448 EACH 7.00  
1940 PASSENGER  
01A-13448 EACH 10.00

1942-48 PASSENGER  
POLISHED STAINLESS  
21A-13448 EACH 10.00

**TAIL LAMP RING**

1932-36 PASSENGER  
1932-48 PICKUP  
1938-48 SEDAN DELIVERY  
1938-47 STATION WAGON  
B-13456 EACH 1.00

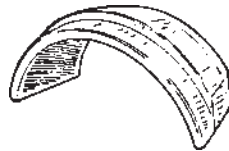

**LICENSE PLATE LENS**

1929-32 PASSENGER, 29-42 PICKUP  
B-13445 EACH 5.00  
1933-36 PASSENGER, 46-52 PICKUP  
40-13445 EACH 6.00  
1937 PASSENGER  
78-13445 EACH 6.00  
1940-48 PASSENGER  
99A-13445 EACH 6.00

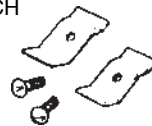

**LICENSE PLATE LENS RETAINER CLIPS**

1932 PASSENGER  
B-13446-K KIT 2.00  
1933-37 PASSENGER  
1932-47 PICKUP  
40-13446-K KIT 2.00

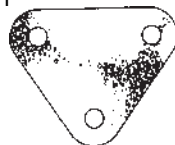

**LICENSE PLATE BRACKET-TO-TRUNK PAD**

1938-48  
81A-13446 EACH 3.25

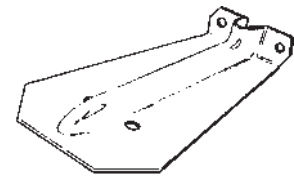

**TAIL LAMP BRACE**

1933-34  
40-13463 EACH 15.00

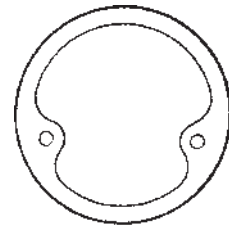

**TAIL LIGHT LENS GASKETS**

1932 PASSENGER  
B-13461 PAIR 1.50  
1933-36 PASSENGER, 35-48 SEDAN  
DELIVERY, 46-48 PICKUP  
40-13460/1 PAIR 1.50  
1937 PASSENGER  
78-13461 PAIR 1.50  
1938-39 PASSENGER  
81A-13461 PAIR 1.50  
1940 PASSENGER  
01A-13461 PAIR 1.50  
1941 PASSENGER  
11A-13461-A KIT 1.50  
1942-48 PASSENGER  
21A-13461 PAIR 1.50



**LICENSE PLATE LIGHT LENS GASKETS**

1932  
B-13447 EACH 1.50  
1933-36  
40-13447 EACH 1.50  
1937  
78-13447 EACH 1.50  
1938-39  
81A-13568 EACH 1.25  
1940  
01A-13568/9 2 PIECES 2.00  
1941-48  
11A-13568/9 3 PIECES 1.00

# TAIL LAMP LENSES (GLASS)



**1932 PASSENGER, 32-42 PICKUP**  
 B-13450 EACH 10.00  
 BLUE DOT  
 B-13450-BD EACH 15.00

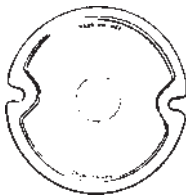

**1933-36 PASSENGER, 46-47 PICKUP**  
 40-13450 EACH 10.00  
 BLUE DOT  
 40-13450-BD EACH 15.00

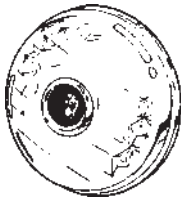

**1937 PASSENGER**  
 78-13450 EACH 10.00  
 BLUE DOT  
 78-13450-BD EACH 15.00

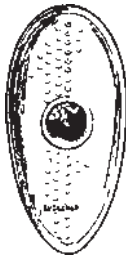

**1938-39 PASSENGER**  
 81A-13450 EACH 10.00  
 BLUE DOT  
 81A-13450-BD EACH 15.00

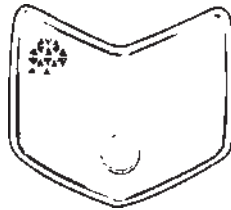

**1940 PASSENGER**  
 01A-13450 EACH 10.00  
 BLUE DOT  
 01A-13450-BD 15.00



**1941 PASSENGER**  
 11A-13450 EACH 10.00  
 BLUE DOT  
 11A-13450-BD EACH 15.00

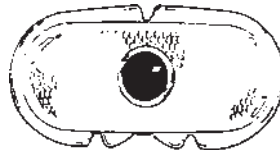

**1942-48 PASSENGER**  
 21A-13450 EACH 10.00  
 BLUE DOT  
 21A-13450-BD EACH 15.00



**BLUE DOT LENS WITH CHROME RIM GLASS**  
 BD-13400 EACH 6.00



**DECK BASE LENS**  
 1939 MERCURY  
 1940-48 FORD  
 99A-13564 EACH 6.00



## LIGHT BULBS

1932-48 LICENSE PLATE LIGHT  
 1932-36 PARKING LAMP  
 1932 & 35-39 INSTRUMENT PANEL  
 B-13466-6 EACH (6 VOLT) 2.00  
 B-13466-12 EACH (12 VOLT) 2.00

1937-40 PARKING LAMP  
 1941-48 INSTRUMENT PANEL  
 1938-48 CLOCK  
 1946-48 RADIO  
 78-13466-6 EACH (6VOLT) 2.00  
 78-13466-12 EACH (12 VOLT) 2.00

1932 TAIL LAMP & BRAKE LAMP  
 1942-48 BACK-UP LAMP  
 B-13465-6 EACH (6 VOLT) 2.00  
 B-13465-12 EACH (12 VOLT) 2.00

1933-37 TAIL LAMP  
 40-13465-6 EACH (6 VOLT) 3.75  
 40-13465-12 EACH (12 VOLT) 3.75

1938-48 TAIL LAMP  
 1941-48 PARKING LAMP W/TURN SIG.  
 11A-13465-6 EACH (6 VOLT) 2.00  
 11A-13465-12 EACH (12 VOLT) 2.00

1933-34 INSTRUMENT PANEL  
 40-13730-6 VOLT EACH 2.00  
 40-13730-12 VOLT EACH 2.00

1941-48 CIGAR LIGHTER  
 1938-48 HIGH BEAM JEWEL  
 1940 INSTRUMENT PANEL  
 1939-48 HEATER SWITCH  
 48-15021 6 OR 12 V EACH 2.00

**PLEASE INQUIRE FOR THE BULBS YOU NEED!  
 WE STOCK EVERYTHING FROM QUARTZ-HALOGEN 6 VOLT & 12 VOLT TO DASH LIGHT BULBS 6 VOLT & 12 VOLT!**

**ASK ABOUT MERCURY**

# TAIL LAMP

(CONT'D.)

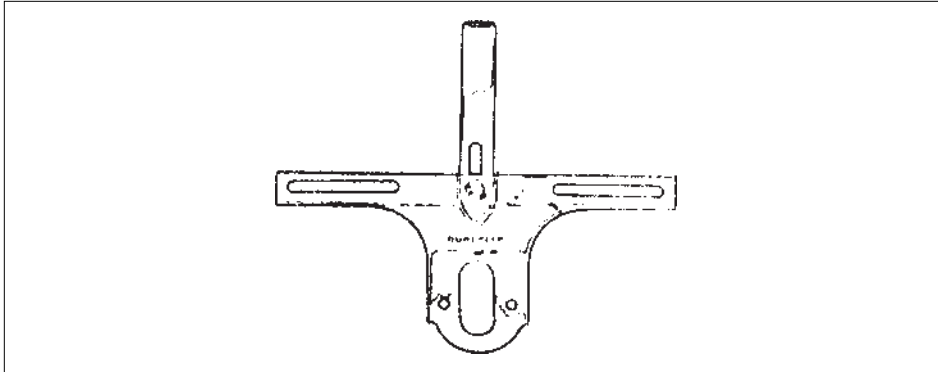

### REAR LICENSE PLATE BRACKETS

1932-47 PICKUP & WAGON BLACK A-13406-B EACH	30.00	1937 PASSENGER (INCLUDES STAND) BLACK 78-13406-B EACH	35.00
STAINLESS STEEL A-13406-SS EACH	35.00	STAINLESS STEEL 78-13406-SS	INQUIRE
1932 PASSENGER BLACK B-13406-B EACH	30.00	1938-48 PASSENGER BLACK 01A-13406-B EACH	30.00
STAINLESS STEEL B-13406-SS EACH	35.00	STAINLESS STEEL 01A-13406-SS EACH	35.00
1933-36 PASSENGER BLACK 40-13406-B EACH	30.00		
STAINLESS STEEL 40-13406-SS EACH	35.00		

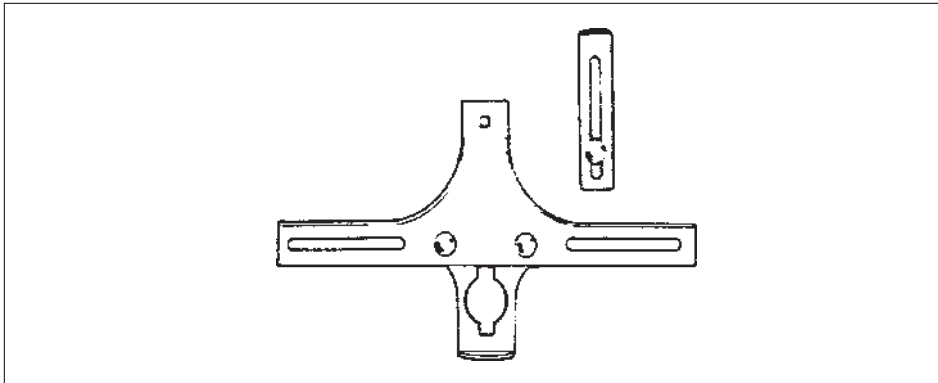

### FRONT LICENSE PLATE BRACKETS

1932 PASSENGER & PICKUP BLACK B-5034-B EACH	30.00	1937-38, 39 STANDARD PASSENGER & PICKUP- BLACK 78-5034-B EACH	30.00
STAINLESS STEEL B-5034-SS EACH	35.00	STAINLESS STEEL 78-5034-SS	35.00
1933-36 PASSENGER & PICKUP BLACK 40-5034-B EACH	30.00	1939 DELUXE, 40 PASSENGER & 1940-41 PICKUP BLACK 91A-5034-B EACH	30.00
STAINLESS STEEL 40-5034-SS EACH	35.00	STAINLESS STEEL 91A-5034-SS EACH	35.00



### TAIL LAMP PADS

1933-34 PASSENGER 40-13520 PAIR	10.00
1935 PASSENGER 48-13520 PAIR	10.00
1936 PASSENGER 68-13520-A PAIR	10.00
1936 CONVERTIBLE SEDAN 68-13520-B PAIR	10.00
1937 PASSENGER 78-13520 PAIR	10.00
1937 PASSENGER (NOT BEADED) 78-13520-NB PAIR	10.00
1938-39 PASSENGER 81A-13520 PAIR	10.00
1938 PASSENGER (RUBBERIZED CORK) 81A-13420 PAIR	10.00
1940 PASSENGER 01A-13420 PAIR	10.00
1941 PASSENGER 11A-13420 PAIR	10.00
1942-48 PASSENGER 21A-13420/1 PAIR	10.00
1942-48 PASSENGER "UNIVERSAL" 21A-13520 PAIR	10.00
1939 MERCURY 99A-13420/1 PAIR	30.00
1940 MERCURY 09A-13420/1 PAIR	60.00
1941 MERCURY 19A-13420/1 PAIR	INQUIRE
1942-48 MERCURY 29A-13420/1 PAIR	21.00

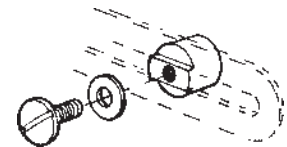

### LICENSE PLATE MOUNTING KIT

1932-48 B-13409-MB KIT	5.00
---------------------------	------

CALL: 1-800-532-1932

COMING SOON !!!- TRY OUR  
WEBSITE AT: [allfordparts.com](http://allfordparts.com)  
E-mail: [allford@jps.net](mailto:allford@jps.net)



**ALL FORD PARTS**

**1600 DELL AVENUE, SUITE A, CAMPBELL, CALIFORNIA 95008**

**408-378-1935 • 1-800-532-1932 • FAX: 408-866-1934**